

Project no: 608860

Project acronym: IDE4L

Project title: IDEAL GRID FOR ALL

Deliverable 5.4:
Report on congestion management in distribution networks with day-ahead dynamic grid tariffs

Due date of deliverable: 29.02.2016

Actual submission date: 26.02.2016

Start date of project: 01.09.2013 Duration: 36 months

Lead beneficiary name: Technical University of Denmark (DTU), Denmark

Authors:

Shaojun Huang (DTU), Qiuwei Wu (DTU)

Project co-funded by the European Commission within the Seventh Framework Programme (2013-2016)		
Dissemination level		
PU	Public	X
PP	Restricted to other programme participants (including the Commission Services)	
RE	Restricted to a group specified by the consortium (including the Commission Services)	
CO	Confidential, only for members of the consortium (including the Commission Services)	

Track Changes

Version	Date	Description	Revised	Approved
0.1	19-08-2015	Preliminary version	Shaojun Huang (DTU) Qiuwei Wu (DTU)	
0.2	15-02-2016	First draft.	Shaojun Huang (DTU) Qiuwei Wu (DTU)	
0.3	26-02-2016	Final version	Shaojun Huang (DTU) Qiuwei Wu (DTU)	

Contents

Abbreviations.....	5
Executive Summary	6
1 Introduction.....	7
2 Review of Incentive Based Demand Response Program	8
2.1 Peak Time Rebate	8
2.2 Coupon Incentive.....	8
2.2.1 Three-layer Information Exchange Scheme	9
2.2.2 Top-layer Optimization.....	9
2.2.3 Middle-layer Optimization.....	10
2.2.4 Bottom-layer Optimization.....	11
2.3 Monetary Incentive	11
2.3.1 Optimal Energy Planning of the Customers at the Prescheduling Stage.....	13
2.3.2 Optimal Energy Planning of the Customers at the Rescheduling Stage.....	13
2.3.3 Optimal Energy Planning of the Aggregator at the Rescheduling Stage	14
2.4 Flexibility service market.....	15
3 Review of Price or Tariff Based Demand Response Program.....	17
3.1 Time-of-day (TOD) Tariff.....	17
3.2 Power Tariff	17
3.2.1 Power Tariff for Household Customers	18
3.2.2 Power Band Tariff	18
3.3 Day-ahead Dynamic Tariff	19
3.4 Distribution capacity market	21
3.5 Intra-day shadow price.....	22
3.6 Summary of the methods.....	24
4 Design Specifications	26
4.1 Day-Ahead DT Design Specification.....	26
4.1.1 Description.....	26
4.1.2 Interface	26
4.1.3 Step-by-step descriptions of the algorithm.....	28
4.2 Demand Response Design Specification.....	29
4.2.1 Description.....	29
4.2.2 Interface	30
4.2.3 Step-by-step description of the algorithm	31

5	Day Ahead Dynamic Tariff	32
5.1	Background.....	32
5.2	Optimal Energy Planning for EV and HP	32
5.2.1	Spot Price Prediction	33
5.2.2	Optimal EV Charging.....	34
5.2.3	Optimal HP Planning.....	35
5.3	DLMP and DT Through QP	37
5.3.1	Decentralized Congestion Management Through the DLMP and DT Concept	37
5.3.2	Multiple Solution Issue of the Aggregator Optimization with Linear Programming Formulation	38
5.3.3	QP Formulation and the Proof of Convergence	39
5.4	Case Studies.....	42
5.4.1	Grid Data.....	42
5.4.2	EV and HP Data	44
5.4.3	Case Study Results.....	44
5.5	Conclusion	49
6	CONCLUSIONS	51
	Reference.....	52

Abbreviations

AMI	Advanced metering infrastructure
BRP	Balance responsible party
DT	Dynamic tariff, in this report, it is the same as DADT
DADT	Day-ahead dynamic tariff
DSO	Distribution system operator
DXP	Data exchange platform
DLMP	Distribution locational marginal pricing
DG	Distributed generator
DER	Distributed energy resource
EV	Electric vehicle
HP	Heat pump
IMO	Independent market operator
LM	Lagrange multiplier
LMP	Locational marginal pricing
LSE	Load serving entities
PTR	Peak time rebate
QR	Quadratic program
SP	Solar Power
SOC	State of charge
TSO	Transmission system operator
TOD	Time of day
WP	Wind power

Executive Summary

In order to reduce CO₂ emissions and alleviate the global warming issue, many countries are setting goals to increase the percentage of renewable energy in the total energy consumption. In this process, a large number of distributed energy resources (DER), distributed generation (DG), electric vehicles (EV) and heat pumps (HP), will be largely deployed in electrical distribution networks. Congestion management will be important in the future active distribution networks. In the IDE4L project, work package 5 is dedicated to develop different kinds of congestion management methods. Demand response (DR) is one of the important methods. In this report, as one task of work package 5, the day-ahead dynamic tariff (DADT) method for congestion management in distribution networks is presented. The dynamic tariff (DT) can motivate the flexible demands (EV and HP) to shift their energy consumption in a way that favours the secure operation of distribution networks. Therefore, the DADT method belongs to the DR programs.

The DR programs can be categorized into two categories, i.e. incentive-based DR programs and price-based DR programs. This report reviews the two categories separately. The DADT method belongs to the price-based DR programs.

This report introduces the concept of the DADT method and its formulation using quadratic programming (QP). The QP formulation of the DADT method allows a decentralized control structure of the DR program. The DSO determines the DADT through an optimal energy planning with network constraints included. The aggregators follow the DADT and make their own optimal energy planning. The convergence between the energy planning of the DSO and the aggregators is proven.

1 Introduction

The IDE4L project aims at defining and developing many important functions of active distribution networks. Congestion management is one of the key topics included in this project and work package 5 is dedicated to it, i.e. developing congestion management algorithms that can alleviate the potential congestions in distribution networks due to high penetration of distributed energy resources (DERs).

A distribution system operator (DSO), who has the main responsibility for resolving congestions in distribution networks, can choose to reinforce the network through their long term planning or employ market/price based methods [1]–[3] to influence the DERs to respect the system capacity limits. Compared to direct control methods for congestion management [4], [5], price-based methods can maximize the social welfare, cause less discomfort to customers and encourage more participation in the energy planning.

In this report, the focus will be price-based methods. Particularly, the DADT method for congestion management will be presented in this report.

The publications related to this report and supported by the IDE4L project include:

1. S. Huang, Q. Wu, Z. Liu, and A. H. Nielsen, “Review of congestion management methods for distribution networks with high penetration of distributed energy resources,” in Proc. IEEE PES Innovative Smart Grid Technologies Europe, pp. 1–6.
2. S. Huang, Q. Wu, S. S. Oren, R. Li, and Z. Liu, “Distribution Locational Marginal Pricing Through Quadratic Programming for Congestion Management in Distribution Networks,” IEEE Trans. Power Syst., vol.30, no.4, pp. 2170–2178, Jul. 2015.
3. S. Huang, Q. Wu, L. Cheng, and Z. Liu, “Optimal Reconfiguration-Based Dynamic Tariff for Congestion Management and Line Loss Reduction in Distribution Networks,” IEEE Trans. Smart Grid, vol. PP, no.99, pp. 1–1, 2015.
4. Shaojun Huang, Qiuwei Wu, Zhaoxi Liu, and Haoran Zhao, “Sensitivity analysis of dynamic tariff method for congestion management in distribution networks,” in Proc. 2015 IEEE Power & Energy Society General Meeting, pp. 1–6.
5. Shaojun Huang, Qiuwei Wu, Lin Cheng, Zhaoxi Liu, Haoran Zhao, “Uncertainty Management of Dynamic Tariff Method for Congestion Management in Distribution Networks”, IEEE Trans. Power Syst., accepted

The report is organized as follows. Incentive-based demand response (DR) programs, such as peak time rebate program, coupon incentive program and monetary incentive program, are reviewed in Chapter 2. Several price-based DR programs, including the day-ahead dynamic tariff (DADT) program, are reviewed in Chapter 3. In order to integrate the DADT program into work package 5 of the IDE4L project, namely congestion management of the distribution network, the interfaces with other tasks for the DADT and DR functions are presented in Chapter 5. Then the focus is given to the DADT program: The notion and theory of DADT including offline simulation are presented in Chapter 5. Conclusions are drawn in Chapter 6.

2 Review of Incentive Based Demand Response Program

In this chapter, several incentive based demand response programs for congestion management in distribution networks are reviewed.

2.1 Peak Time Rebate

In a peak time rebate (PTR) program, customers can get a rebate for reducing their load at specified peak hours on critical days of a year [6]. The utilities (transmission system operator (TSO) and DSO) identify the critical day and the peak hours before the day-ahead market, so that the customers have enough time to make their energy plans. Critical days and peak hours can occur if the predicted production is very low or the predicted consumption is very high, e.g. due to extreme weather in summer or winter, the cooling or heating demands suddenly grow up. Without the PTR program, the utilities will have to resort to some unusual means, such as starting the gas turbines or curtailment of non-critical loads, which are expensive and/or uncomfortable for customers. Instead, the utilities can use the PTR program to motivate the flexible demands to shift the loads to off-peak hours. In this way, the 'peak' at predicted peak hours will be reduced and the flexible demands can get a reward according to the size of the reduction.

One key point of the PTR program is for the utility to estimate the baseline load, which is employed to determine the size of the reduction. Without accurate estimation of the baseline load, the reduction of the flexible demands and the rebate based on the reduction will fail. The baseline load refers to the normal load profile without the PTR program.

Another key point of the PTR program is for the utility to determine the rebate rate. The rebate paid by the utility to the customers is determined by the rebate rate multiplied by the size of the reduction. The utility can determine the rebate rate according to the reduction requirement and the price elasticity of the demand. However, the price elasticity is usually difficult to estimate, as there are many types of elasticity, such as self-elasticity, cross-elasticity, one-hour elasticity and 24-hour (intertemporal) elasticity as shown in [7].

From the utility side, the benefits of using a PTR program include: 1) remove potential consumption spikes, and thereby increase the system security; 2) reduce the needs for reserves and thereby reduce the system operation cost; 3) postpone the needs of system reinforcement.

From the customer side, the benefit of participating in a PTR program is the monetary reward of providing DR, while experiencing no or little inconvenience and discomfort.

The limitation of using the PTR program comes from the abovementioned two key points. It's difficult to acquire the baseline load profile without communication with the customers. Similarly, without communication with the customers, it is difficult for the utility to determine the rebate rate such that it can attract enough flexible demands to participate in the PRT program.

2.2 Coupon Incentive

Reference [8] has proposed the coupon incentive-based demand response program that can benefit both the load serving entities (LSE) and the customers. In Europe, LSE refers to retailers or aggregators. The LSE buys electricity from markets and sells it to their customers. Outside of Europe, LSE may refer to different entities due to different structures of the electricity markets.

2.2.1 Three-layer Information Exchange Scheme

The LSE is integrated into a real-time (10-15 minutes ahead of operation) pricing wholesale market through the three-layer information exchange scheme [8], which is shown in Figure 2-1. The top layer plays the role of clearing the real-time electricity market. It may also broadcast important information, such as extreme weather information, to help the production companies and LSEs make their energy plan decisions. The top-layer interacts with the production companies and the LSEs from the middle-layer.

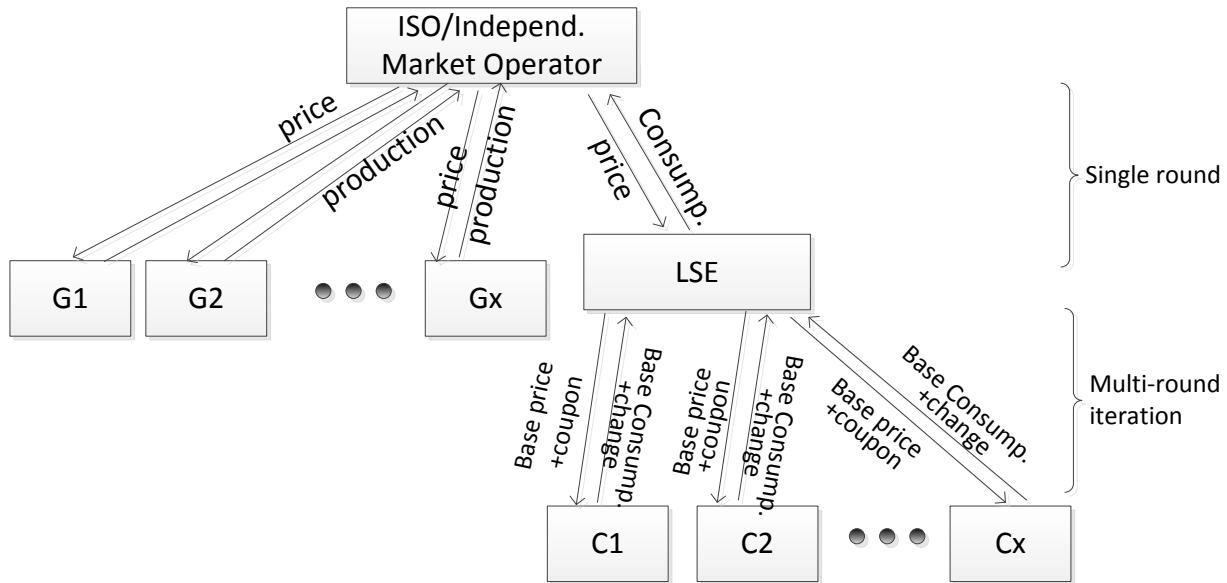

Figure 2-1: The three-layer information exchange scheme for integrating coupon incentive program

The middle-layer consists of production companies and LSEs. After receiving important information from the top-layer that may affect the electricity clearing price, the LSE will optimize the energy consumption plan to maximize its profit. For instance, if extremely high spikes in electricity clearing price are expected, the LSE may seek demand response to reduce the consumption. The result of such actions would be that the high price spikes are avoided/reduced. The LSE interacts with its customers through multi-round iterations to determine the proper coupon price so that there is sufficient demand response to reduce the expected clearing price. The base price determined by the LSE for the customers is fixed for a long period such as one season or one year.

The bottom-layer consists of the customers of the LSEs. The customers are equipped with an energy management system (EMS) to optimize the energy consumption plan according to the base price and the coupon offered by the LSE. The interaction between the LSE and the customers is based on multi-round iterations in order to help the LSE determine the proper coupon price.

2.2.2 Top-layer Optimization

The top-layer optimization is a least cost economic dispatch that the independent market operator (IMO) employs to clear the market. The optimization is as follows [8].

$$\min \sum_{i \in N_g} C_i(p_i^g) \quad (2.1)$$

subject to,

$$\sum_{i \in N_g} p_i^g = \sum_{j \in N_d} (p_j^d - \Delta p_j^d) \quad (2.2)$$

$$p_i^{g \min} \leq p_i^g \leq p_i^{g \max}, \forall i \in N_g \quad (2.3)$$

where,

C_i is the cost function of generator i ,

p_i^g is the production of generator i ,

p_j^d is the consumption of demand j ,

Δp_j^d is the consumption change of demand j ,

N_g is the set of generators,

N_d is the set of demands,

$p_i^{g \min}$ is the minimum production of generator i ,

$p_i^{g \max}$ is the maximum production of generator i .

2.2.3 Middle-layer Optimization

The LSE buys energy from the wholesale market and sells it to their customers. Therefore, the optimization of the LSE is to maximize its profit from the buying and selling process. With the coupon incentive demand response program, it may pursue more profit by avoiding the price spikes of the wholesale market. The LSE can use the following optimization to maximize the profit, where the profit from both the normal service (buy and sell) and the coupon incentive program is included [8].

$$\max E[h^r(p_d - \Delta p_d) - h^s(p_d - \Delta p_d) - h^c \Delta p_d] \quad (2.4)$$

subject to,

$$\Delta p_d = \sum_{j \in N_d} \Delta p_j^d \quad (2.5)$$

$$\Delta p_j^d = g_j(h^c), \forall j \in N_d \quad (2.6)$$

where,

N_d is the set of demands,

h^r is the retail price for the customers,

h^s is the energy price of the spot market (wholesale market),

h^c is the coupon price,

p_j^d is the consumption of demand j ,

Δp^d is the total consumption change of the demand,

Δp_j^d is the consumption change of demand j ,

$g_j(h^c)$ is the function reflecting the response behavior of customer j with respect to the coupon price h^c .

In the objective function (2.4), the first term is the income of selling the energy to the customers, the second term is the cost of buying the energy from the spot market, and the third term is the cost of using the coupon incentive program. The function g_j may be a linear function, piecewise linear function or more generally, a function having non-closed form. If g_j has non-closed form, an iterative process between the LSE and its customers is needed to solve the LSE optimization (2.4)-(2.6) and the customer optimization (2.7)-(2.8).

2.2.4 Bottom-layer Optimization

In the bottom layer, the customers will use the following optimization to determine how they will respond to the coupon price. It can maximize the surplus, i.e. the utility (here it is an economic term, means 'perceived benefit or satisfaction of a good or service') minus the cost.

$$\max y_j - h^r p_j^d + h^c (p_j^{d,0} - p_j^d), \quad (2.7)$$

subject to,

$$y_j \leq a_{jk} p_j^d + b_{jk}, \forall j \in N_d, k = 1, 2, 3, \dots, m, \quad (2.8)$$

where,

h^r is the retail price for the customers,

h^c is the coupon price,

y_j is the utility the customer can get from consuming the energy p_j^d ,

$p_j^{d,0}$ is the baseline consumption,

p_j^d is the consumption of demand j ,

a_{jk} and b_{jk} are the coefficients of the piece-wise linear function with m pieces to describe the utility function.

2.3 Monetary Incentive

One of the shortcomings of the coupon based incentive program is that it only considers the economic profit of the LSEs, without considering the limits of the distribution networks and the intertemporal effect of the flexible demands. Reference [9] proposed a DR program via monetary incentives, where the abovementioned shortcomings are overcome. This DR program offers the aggregators a chance to maximize the profit while the network limits are respected. When there are several aggregators in one distribution network, one aggregator can't know how the other aggregators will make their energy plans and therefore doesn't know the potential overloading of the network. Therefore, this DR program is suitable for the situation where there is only one aggregator in one distribution network. The aggregator can use the method described below to transform an expected overloading into economic incentive information and influence the behaviour of the flexible demands.

The DR program via monetary incentives has two stages, namely the prescheduling stage and the rescheduling stage. In the prescheduling stage, the aggregator predicts the energy prices of the wholesale market and publishes the retail prices for the customers for the next 24 hours. In this stage, the network limits are not considered and the energy profiles from the customers form the baseline load.

The rescheduling stage is required if congestions are expected when approaching the operation time. This stage has a rolling time window, e.g. 24 hours. The optimal energy planning is performed for the rolling time window, but only the planning of the first period is realized. Then roll to the next time period. In this stage, the aggregator will send the monetary incentive signals (price signals) to the customers and the customers perform their own optimal energy planning of the household appliances and their EVs for each incentive signal. The incentive signals are discrete and the number of the signals is limited. The customers then send the load profiles with respect to each incentive signal to the aggregator. The aggregator will perform an optimal energy planning subject to network constraints and determine which demand responses from the customers are selected.

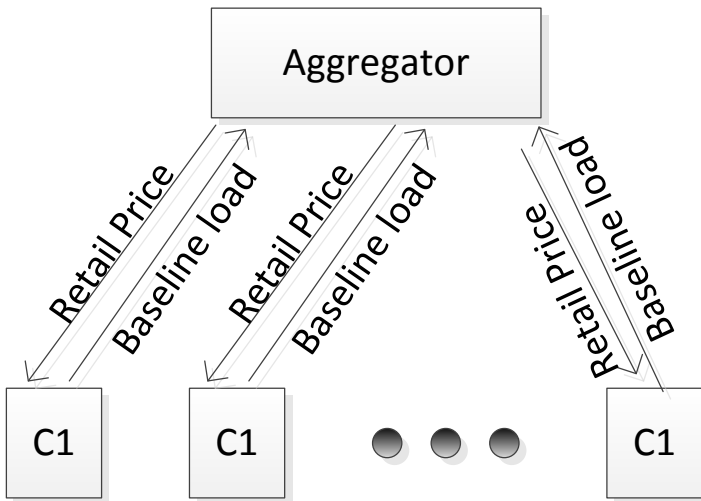

Figure 2-2. Information interchange between the aggregator and customers at prescheduling stage

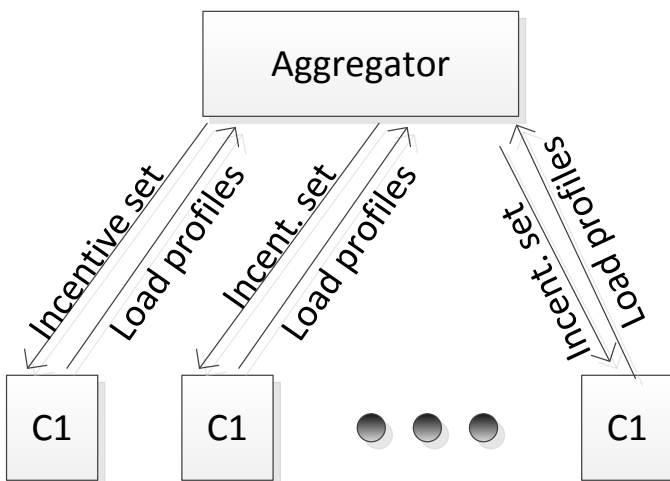

Figure 2-3. Information interchange between the aggregator and customers at rescheduling stage

2.3.1 Optimal Energy Planning of the Customers at the Prescheduling Stage

At the prescheduling stage, the aggregator sends retail prices, consisting of predicted energy price, network tariff and reasonable profit margin, to their customers. The customers will optimize the energy planning of flexible demands, such as EVs and HPs, through the following optimization [9].

The customers can have many different flexible demands. In order to briefly describe the idea of the DR program proposed in [9], electric vehicles (EVs) are chosen as the flexible demands in the household of each customer.

$$\sum_{t \in N_t, v \in N_v} h_t^r p_{tv}^e, \quad (2.9)$$

subject to,

$$p_t^{base} + \sum_{v \in N_v} p_{tv}^e \leq p^{fuse}, \quad (2.10)$$

$$\sum_{t \in N_t} p_{tv}^e \geq d_v, \forall v \in N_v \quad (2.11)$$

where,

h_t^r is the retail price for the customers at time t ,

p_{tv}^e is the charging/discharging power of EV v in one household at time t ,

p_t^{base} is the estimated power of inflexible demands in one household at time t ,

p^{fuse} is the allowed power of the fuse of the household,

d_v is the demand of EV v ,

N_v is the set of EVs in one household.

2.3.2 Optimal Energy Planning of the Customers at the Rescheduling Stage

At the rescheduling stage, the customers will individually make demand response profiles according to each of the received incentives. Namely, if the aggregator sends out 6 (level or type) incentives, the customers will make optimal energy planning 6 times.

The following optimization is employed by each customer [9]. For a given incentive $\beta_i, i \in N_i$,

$$\sum_{t=\tau}^{\tau+m-1} ((h_t^r + h_t^{\beta_i}) \sum_{v \in N_v} \Delta p_{tv}^e), \quad (2.12)$$

subject to (2.10), (2.11) and,

$$p_{tv}^e = u_{tv}^{pre} + \Delta p_{tv}^e, \forall t \in N_t, v \in N_v. \quad (2.13)$$

τ represents the next operation period,

m is the number of future periods the rescheduling stage will look into,

h_t^r is the retail price for the customers at time t ,

$h_t^{\beta_i}$ is the price of incentive β_i ,

p_{tv}^e is the charging power of EV v ,

Δp_{tv}^e is the change of the charging power of EV v ,

u_{tv}^{pre} is the charging power of EV at the prescheduling stage.

2.3.3 Optimal Energy Planning of the Aggregator at the Rescheduling Stage

After receiving DR profiles from the customers, the aggregator will make an optimal energy planning through a mixed integer program to determine which DR will be selected. At the rescheduling stage, the objective of the optimization is to maximize the profit while the network constraints is considered. The following optimization is employed by the aggregator [9].

$$\begin{aligned} \max \quad & \sum_{t=\tau}^{\tau+m-1} \sum_{b \in N_b, c \in N_c, i \in N_i} (h_t^r + h_t^{\beta_i}) (u_{tbc}^{re} - u_{tbc}^{pre}) n_{tbc} \\ & - \sum_{t=\tau}^{\tau+m-1} h_t^s u_t^s \end{aligned} \quad , \quad (2.14)$$

subject to,

$$\begin{aligned} u_t^s = \quad & \sum_{b \in N_b, c \in N_c, i \in N_i} (u_{tbc}^{re} - u_{tbc}^{pre}) n_{tbc} \quad , \\ & + \sum_{l \in N_l} R_l I_l \quad , t = \tau, \tau + 1, \dots, \tau + m - 1 \end{aligned} \quad (2.15)$$

$$\sum_{i \in N_i} n_{tbc} = 1, \forall t \in N_t, b \in N_b, c \in N_c \quad , \quad (2.16)$$

and u_{tbc}^{re} fulfil the nonlinear power flow constraints and the network limits.

N_b is the set of buses in the distribution network,

N_c is the set of customers,

N_l is the set lines,

N_i is the set of incentives,

R_l is the resistance of line l ,

I_l is square of the current of line l ,

h_t^r is the retail price for the customers at time t ,

h_t^s is the energy price on spot market at time t ,

$h_t^{\beta_i}$ is the price of incentive β_i ,

n_{tbc_i} is a binary variable indicating whether the specified DR is selected,

u_t^s is the additional power needs to be bought from the spot market,

$u_{tbc_i}^{re}$ is the load profile at the rescheduling stage,

$u_{tbc_i}^{pre}$ is the load profile at the prescheduling stage.

In (2.15), the first term on the right side is the total consumption change of the customers, and the second term is the total line loss. Constraint (2.16) is to make sure that only one incentive is selected for one customer at one time.

2.4 Flexibility service market

The authors of [10] proposed a new notion to solve the congestion: FLECH - flexibility clearing house. The aggregators do not need to buy the distribution grid capacity, i.e. they can make their own demand plan without considering the distribution grid limits. Instead, the DSO needs to buy the flexibility services to solve the congestion problem, e.g. buy a service which is to reduce the demand at a certain time and a certain location. The overall function is shown in Figure 2-4.

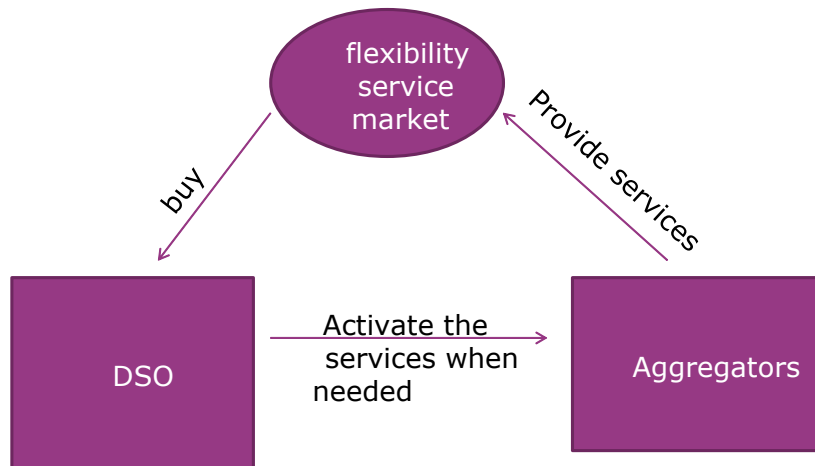

Figure 2-4: function illustration of FLECH

The aggregators can participate in the market based on their own benefits. They can sell some flexibility services to the market if they have such flexibility and it is economically beneficial to them. The DSO will decide whether to buy the flexibility services from the market or reinforce their grids.

The possible flexibility services, as mentioned in [10], include FS_{OP} , FS_{OU} , FS_{OR} , FS_{OC} and FS_{OM} .

FS_{OP} will be activated before the overloading (e.g. 70% of the maximum loading limit) time.

FS_{OU} will be activated exactly when the overloading appears.

FS_{OR} will be activated sharply when the line loading hits the maximum limit (i.e. 100%) or there is a fault at the neighboring feeder and the line loading is above 70%.

FS_{OC} promises a feeder capacity limit specified by the DSO (e.g. 70%) will not be violated.

FS_{OM} means that the Aggregators have the obligation to guarantee that their local portfolio will not exceed a certain limit (e.g. 70%) specified by the DSO.

The flexibility service market is working in parallel with the conventional markets, such as the spot market, the intra-day and intra-hour market. Issues like how to make the flexibility services optimally, how to fulfill the demands of the customers after the services are activated (e.g. the batteries still need to be charged before a predefined time), however, are not mentioned in [10].

3 Review of Price or Tariff Based Demand Response Program

In this chapter, several price or tariff based methods (demand response program) for congestion management in distribution networks are reviewed.

3.1 Time-of-day (TOD) Tariff

The one-time tariff (a widely used term for this in Finland is general tariff) is a traditional tariff structure, which is usually meant for customers whose yearly energy consumption is relatively small, e.g. the household customers with yearly energy consumption less than 10 MWh without electrical heating. In Finland, the general tariff structure consists of a fixed basic fee (€/month) and an energy fee (€/kWh) which is independent of time, i.e. the same volumetric fee for every hour of the year. The size of the basic fee can depend on the customer's fuse size or it can be the same for every customer of the general tariff. The general tariff's structure does not include any incentives from the customer's perspective to change the consumption habits since the energy fee is the same for every hour. The only guiding factor is the size of the energy fee since a high unit price encourages the customer to use less energy in general, i.e. energy efficiency.

The time-of-day (TOD) tariff is usually meant for customers who have larger loads that consume more energy. These kinds of loads could be e.g. various kinds of electrical heating or cooling applications. The TOD tariff's structure consists of a fixed basic fee (€/month) and time variant energy fee (€/kWh). The energy fee can have two or more different levels.

In Finland, the usual TOD tariffs are called night-time or seasonal tariffs where the energy fee components have at least two different levels, e.g. daytime/night-time or winter working day/other time. In the night-time tariff, the energy fee is more expensive during the day compared to night-time whereas the seasonal tariff's energy fee is more expensive on winter working days compared to other times. The basic fee in both tariffs (the night-time tariff and the seasonal tariff) can depend on the customer's fuse size in the same way as the general tariff's basic fee.

Compared to the general tariff, the TOD tariff has better incentives e.g. for congestion management. The cheaper energy fee for different times of the day guides the customers to shift loads to night-time. The downside of the TOD tariffs is when all customers of the TOD tariff turn their loads on/off at the same time. Simultaneous switching-on of many loads could result in a quite high peak load which could exceed the network's capacity. To prevent these sudden peak loads from happening, the loads are usually turned on/off in turns e.g. in Finland starting from 10pm.

The TOD tariffs have already been in use for many years in Finland. The basis to use the TOD tariffs comes partly from the scheduling of electricity generation. When the load is distributed, at some level, evenly over daytime and night-time, the base generation e.g. nuclear power plants can run constantly on high capacity.

3.2 Power Tariff

The power tariff is meant to be used by larger customers (e.g. industrial companies) who have larger loads and the ability to measure and control their loads better than household customers. The power tariff structure usually consists of a fixed basic fee (€/month), a power fee (€/kW) and an energy fee (€/kWh) which can have two or more different levels same as the TOD tariff.

The power fee component in the power tariff executes the matching principle in a better way than the general or the TOD tariff since the customer pays for the capacity (power) separately. The power by which

the power fee is paid can be the highest peak average power of last year or some combination of average hourly powers calculated in a certain way. Because of the separate power component in the tariff, the end customer has a clear financial incentive to lower peak power since it has a direct impact on the customer's costs.

The interest for new distribution tariff structures is increasing. The idea concerning alternative distribution tariff structures is to include a capacity-based (power-based) component into the household customer's tariff so that the peak powers in the electricity network could be lowered and the utilization rate of the electricity network will be higher.

There are quite a few variations of power-based distribution tariffs such as regular power tariff intended for household customers, power band tariff, critical peak pricing tariff and dynamic tariff. These are just a few examples and many other variations exist.

The use of power-based distribution tariffs means that the end customer has to have a way of knowing how the electricity is consumed [11]. In Finland, most of the DSOs' customers have AMR-meters to measure hourly data and in some cases it is possible for customers to see the hourly consumption e.g. via a web application. Smart solutions together with home automation and power-based tariffs could result in a situation where all electricity market participants benefit.

With distribution tariffs, the legislative and regulative principles and constraints have to be noted. For instance, in the case of congestion in the distribution network, it is not so easy to apply a tariff that has some sort of capacity fee intended for congestion situations in different parts of the grid. The customer has to be able to have some sort of idea about the size of the distribution fee. A single customer does not have the ability to see e.g. the state of the electricity network and whether there is or isn't a congestion situation. Also in Finland, it is not possible, within current legislation's constraints, to have different distribution fees for different parts of the distribution network. The bases of the tariff have to be the same for every customer of the same tariff group.

3.2.1 Power Tariff for Household Customers

The Power tariff for household customers is structurally the same as the previously introduced power tariff. The idea is to have a separate capacity (power) fee in the household customer's tariff structure.

The complexity of the tariff structure compared to the general or the TOD tariffs increases when one extra component is introduced in the tariff structure, which is a downside. The upside of having a separate power-fee is when two different customers of the same tariff have different peak powers but they both pay the same basic fee e.g. general or TOD tariff's basic fee. The customer, who has the smaller peak power, does not necessarily cause as many costs as does the customer with the higher peak power. From the matching principle's point of view, the customer with the lower peak power should not have to pay for the costs caused by the customer who has the higher peak power. If the basis of the tariff is the same for both customers, the power tariff could be one potential solution as a tariff structure.

3.2.2 Power Band Tariff

The power band tariff is a power-based tariff where the customer, in a sense, reserves a band based on the customer's power capacity need. The initial idea and concept of the power band tariff is explained in more detail in [12].

The power band structure could consist of one single price component based on the reserved capacity. The distribution fee paid by the customer would remain the same for a specified time interval e.g. one year. The power band has some perks e.g. the DSO's incomes would be even and predictable and so would be the customer's distribution fee.

There are some downsides in the power band tariff, e.g. if the distribution fee is the same for the whole year and it's based on the customer's peak average hourly power of last year. If the only limiting factor is the peak average hourly power, the customer will have no incentive to lower consumption for other hours of the year. In Finland, the tariff level (band) of a customer would be set by the hours of winter when the temperature is the lowest. During those hours, the electricity consumption is usually the highest. Together with some hourly based energy fee, e.g. SPOT-price dependent energy fee, the power band could even increase the peak powers in the electricity network resulting in overload in secondary substations.

3.3 Day-ahead Dynamic Tariff

In contrast to the above fixed tariff schemes, the dynamic tariff (DT) provides customers with a price that varies day to day; therefore, the price information in the DT can reflect the real energy price more accurately and timely. In the distribution grid, the DT can be used to address grid congestions by means of including congestion costs in the DT. Further details of using the DT to address grid congestion will be discussed in Chapter 5.

The provision of the DT is enabled by smart meter or advanced metering infrastructure (AMI) technologies. The energy consumption of the customers will be measured every period from a few minutes to one hour. The energy cost depends on both the consumption and the price of each period; therefore, the dynamic tariff, which is determined in advance (e.g. day-ahead), can influence the behavior of the energy consumption of the customers.

In this method, the flexible demands are price-sensitive demands by definition and the DSO will find the, theoretically, lowest DT (time-varying) that would cause these flexible demands plus the basic loads (non-flexible demands) to be lower than the line loading limits of the distribution grid.

In [13], a bi-level optimization model was formulated to find the optimal DT:

$$\min \sum_{t \in T} r_t \quad (3.1)$$

s.t.

$$r_t \geq 0 \quad \forall t \in T \quad (3.2)$$

$$f_t \leq f^{\max} \quad \forall t \in T \quad (3.3)$$

$$i = 1, 2, \dots, n_B \quad \min \sum_{t \in T} (r_t + \alpha_t) \tilde{p}_{i,t} + \beta_i \tilde{p}_{i,t}^2$$

$$s.t. \quad e_i^{\min} \leq e_{i,t} \leq e_i^{\max}, t \in T \quad (3.4)$$

$$\tilde{p}_i^{\min} \leq \tilde{p}_{i,t} \leq \tilde{p}_i^{\max}, t \in T$$

This model is exactly reflecting the above concept of the lowest DT, where

$r_t \in R^{n_d}$ is the DT for time t (e.g. from 0 till 23 o'clock of the next day),

$f_t \in R^{n_L}$ is the line loading at time t , f_t could be computed from the flexible demands $\tilde{p}_{i,t} \in R^{m_i}$ and the non-flexible demands $\bar{p}_{i,t} \in R^{m_i}$

α is the predicted baseline spot price, β is the sensitivity parameter (the total spot price is the baseline price plus an additional part which is sensitive to the amount of the flexible demands)

$e_{i,t} \in R^{m_i}$ is the status of the stored energy of the flexible demand, it could be calculated from the previous status, the flexible demands $\tilde{p}_{i,t}$ and the energy usage $u_{i,t}$,

m_i is the number of customers belonging to aggregator i ,

n_L is the number of distribution grid lines,

n_d is the number of load buses,

and T is the set of the time periods.

This model is taken from [13] with some modifications to more closely reflect the above concept and respect the situation of multiple aggregators. The bi-level optimization problem is generally hard to solve.

In the literature [14], the authors introduced the concept of "distribution locational marginal price (DLMP)". The DLMP is closely related to the DT concept: the former is the summation of the latter and the energy price.

According to [14], computing the DT is also easier than solving the above bi-level problem: one-level optimization is enough and the DT is the Lagrange multipliers of the corresponding constraints of the optimization problem.

The DT will be published before the spot market clears. The overall function of this method is illustrated in Figure 3-1.

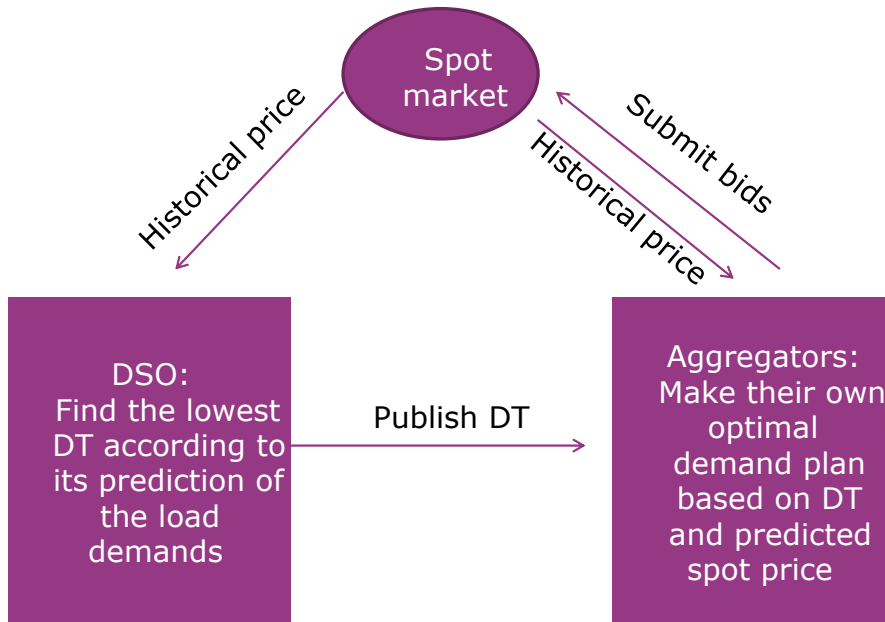

Figure 3-1: Functional illustration of the day-ahead DT method.

3.4 Distribution capacity market

In this method, the capacity of the distribution grid will be allocated to the aggregators and customers with an optimized price.

The distribution capacity market has been described in [15]. The market process is explained as follows:

- (1) The DSO sends an initial network capacity tariff (normally it is zero) to aggregators
- (2) The aggregators individually perform their own optimization with the network tariff and communicate their capacity needs to the DSO.
- (3) The DSO evaluates whether the network capacity (distribution grid line loading) constraints are respected. If not, it raises the network capacity tariff by a small amount during the moments when network capacity is exceeded. It sends the new tariff to aggregators and goes to step 2. If the congestion is solved, go to next step.
- (4) This procedure has converged, resulting in a certain grid tariff and a binding capacity requirement of each aggregator (or the maximum capacity allocated to the aggregator of each moment)

With the allocated maximum distribution grid capacity, the aggregators can send their bids to the spot market.

The mathematic model to describe the above procedure could also be found in [13], which is modified and shown as follows:

$$r_t^{(0)} = 0,$$

solve (3.4) individually by the aggregators, report $\tilde{p}_{i,t}$ to DSO

DSO calculates $f^{(k)}$ based on $\tilde{p}_{i,t}$ and the predicted $\bar{p}_{i,t}$,

$$r_t^{(k+1)} = r_t^{(k)} + \gamma \max(0, f^{\max} - f^{(k)}),$$

stop if $|r_t^{(k+1)} - r_t^{(k)}| \leq \varepsilon$.

In [2], the authors have introduced an alternative method to obtain the grid tariff and the binding charging plan. It is, however, more complicated, hence the details are not included here.

The activities of the corresponding actors are shown in Figure 3-2.

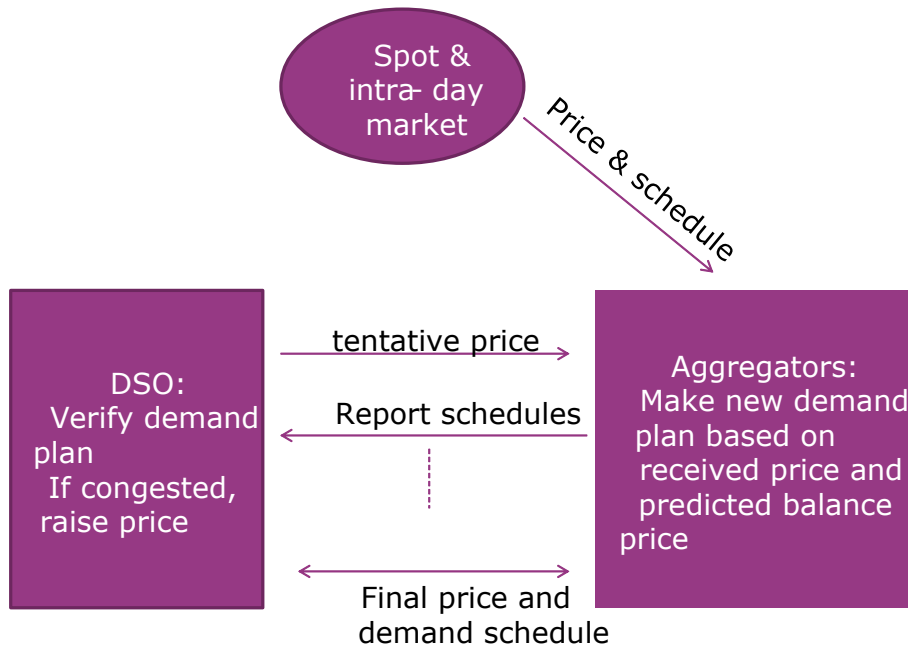

Figure 3-2: Functional illustration of the distribution capacity market method.

3.5 Intra-day shadow price

Literature [1] introduced a congestion preventing method via shadow price. Because the time-frame of this method is tens of minutes before operation time, the “intra-day” term is used to distinguish this method from the above day-ahead methods.

One hour or tens of minutes before operation time, the aggregators (or balance responsible party (BRP)) already know the spot price and also have to obey their demand plan according to their bids, otherwise, a balance price will be charged. However, approaching the operation time, the real demands could be different from the prediction made for the spot market. Aggregators could use their flexible demands to mitigate these differences/imbalances, hence reducing the balance cost incurred. Therefore, a new optimal schedule of the next few hours will come up, because they can have a rather precise prediction of the future demands of this relatively short prediction horizon of a few hours.

Assume the aggregators have already obtained some distribution capacity before the spot market, but now some of them need more and the others need less due to their renewed optimal schedules. Even though they might need more capacity at the same time, they value the additional capacity differently. Therefore, there are needs of trading their capacity with a reasonable price (shadow price). This could be accomplished with the help of the DSO, who pursues no profit in this market but acts as a market operator.

The aggregators could choose their own optimization methods, according to the anticipated balance price of imbalance. The authors of [1] use the following optimization method to illustrate their ideas:

$$\begin{aligned}
 \min \quad & \sum_{i \in n_B, t \in T} (1^T (\bar{p}_{i,t} + \tilde{p}_{i,t}) - q_{i,t})^2 \\
 \text{s.t.} \quad & e_i^{\min} \leq e_{i,t} \leq e_i^{\max}, t \in T \\
 & \tilde{p}_i^{\min} \leq \tilde{p}_{i,t} \leq \tilde{p}_i^{\max}, t \in T \\
 & f_t \leq f^{\max}, t \in T
 \end{aligned} \tag{3.5}$$

where $q_{i,t}$ is the scheduled demands according to the spot market.

Due to the coupling constraint $f_t \leq f^{\max}, t \in T$, it can only be solved in a centralized manner, i.e. can only be solved by the DSO. In order to protect the private information of the aggregators, the authors of [1] proposed an iterative method to solve the problem in a distributed manner.

The optimization problem of each aggregator becomes:

$$\begin{aligned}
 \min \quad & \sum_{t \in T} (1^T (\bar{p}_{i,t} + \tilde{p}_{i,t}) - q_{i,t})^2 + \lambda_t^T v_{i,t} \\
 \text{s.t.} \quad & e_i^{\min} \leq e_{i,t} \leq e_i^{\max}, t \in T \\
 & \tilde{p}_i^{\min} \leq \tilde{p}_{i,t} \leq \tilde{p}_i^{\max}, t \in T
 \end{aligned} \tag{3.6}$$

where $i = 1, 2, \dots, n_B$ is the index of the aggregators,

$\lambda_t \in R^{n_L}$ is the shadow price,

$v_{i,t} \in R^{n_L}$ is the partial power flow due to aggregator i , it can be calculated from $\tilde{p}_{i,t}$ and $\bar{p}_{i,t}$,

and T is a set including the next few hours.

As documented in [1], the shadow price and the new optimal schedule are determined by the following iterative methods:

$$\lambda_t^{(0)} = 0,$$

solve (3.6) individually by the aggregators, report $\tilde{p}_{i,t}$ to DSO

DSO calculates $f_t^{(k)}$ based on $\tilde{p}_{i,t}$ and $\bar{p}_{i,t}$,

$$\lambda_t^{(k+1)} = \lambda_t^{(k)} + \gamma(f_t^{\max} - f_t^{(k)}),$$

stop if $|\lambda_t^{(k+1)} - \lambda_t^{(k)}| \leq \varepsilon$.

In this way, the shadow price and the renewed demand schedule could be obtained. The aggregators need to pay the shadow price in addition to the spot price and the tariff (DT, DLMP or the one from the

distribution capacity market). It can be further concluded that the DSO will not earn a profit from the shadow price because the extra costs caused by shadow price are only among the aggregators (i.e. the sum is zero).

The function of shadow price method is illustrated in Figure 3-3.

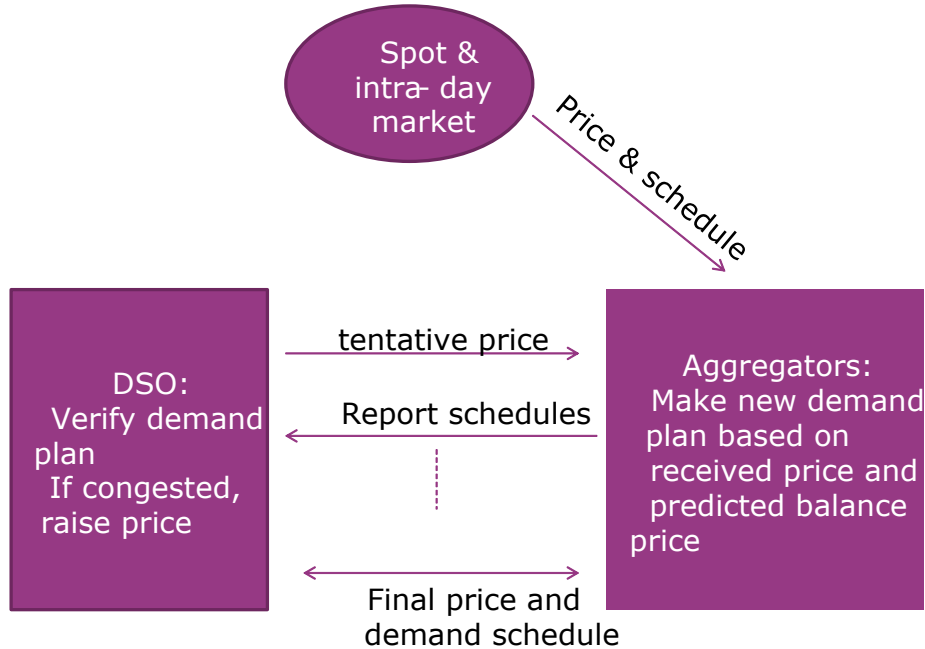

Figure 3-3: Functional illustration of the shadow price method.

3.6 Summary of the methods

The responsible parties (or actors), the relation to the conventional market and time frame and the objective function (the cost function) of the above discussed price based methods are summarized in Table 3-1.

As we can see in the table, these market methods have different time frame, different cost function and different relation between the actors (DSO, Aggregators, Spot market). All of them can have some effect on solving congestion problems with different extent. As market methods, in order to be effective, all of them have a precondition, which is the market liquidity. In other words, there must be sufficient flexible demands participating in the markets, otherwise, the market methods would be inefficient. This is a limitation compared to direct methods.

The DT method and capacity market method are also a power tariff method, due to the fact that the prices of DT or capacity are based on the average power consumption for each predefined time period, e.g. one hour. However, these two methods have better dynamics in terms of fast response to the newest information of the predicted day-ahead energy price and predicted energy requirement of the flexible demands.

Due to the different time frames of these methods, they can be employed in a certain time sequence. For instance, before the day-ahead spot market, the DT method or the capacity market can be employed. Then the intra-day shadow price method can be employed.

If these price based methods are employed, and there are still expected congestions in the distribution network, the direct control methods can be employed to ensure the safe operation of the power system.

Table 3-1

Summary of the price based methods.

	responsible parties	relation to the conventional market/ time frame	objective
TOD tariff	only DSO	long term tariff	not mentioned
Power tariff	only DSO	long term tariff	not mentioned
DT	only DSO	before spot market	lowest DT, that could prevent congestion
Capacity market	DSO and aggregators	before spot market	lowest tariff, that could prevent congestion
intra-day shadow price	DSO and aggregators, but DSO has no profit	after spot market, tens of minutes before operation	lowest imbalance

4 Design Specifications

This Chapter contains the design specifications for the DADT algorithm and the demand response algorithm.

4.1 Day-Ahead DT Design Specification

4.1.1 Description

The Day-Ahead Dynamic Tariff for medium voltage grid congestion management will be developed to alleviate the congestion in the day-ahead time frame. Congestion is defined as the overloading of one or more components in the distribution network. The DADT algorithm receives the preliminary day-ahead energy plan of inflexible demands and the predicted day-ahead local production from the forecaster, the grid model and the grid topology from the control center power control as inputs. The DADT algorithm determines the DADT through an optimal power flow as described in chapter 4. The DADT determined with this procedure can influence the flexible demands in such a way that the congestions in the distribution network are alleviated.

4.1.2 Interface

4.1.2.1 Inputs

This is a description of the inputs.

Input	Data exchanged	Source	Local / Remote	Update schedule	Format	Unit
Grid model and network topology	Line parameters: - connection (from/to) - resistance - reactance - capacitance - phase - loading limit Switches: location and status	to be defined; can be a management system of the DSO	Local	Once a day	Table with integer and floating point numbers	Topology: no unit Loading limit: kW. resistance/ reactance: ohm

Predicted day-ahead system prices	Predicted day-ahead system prices	From spot market	remote	Once a day	table of float numbers	Euro/kWh
Forecasted Conventional/inflexible demand information	Location and quantity	From task 5.1 forecast	Local	Once a day	Table with integer and floating point numbers	Location: no unit; demands quantity: kW per node per hour
Forecasted production information of DG	Location and quantity	From task 5.1 forecast	Local	Once a day	Table with integer and floating point numbers	Location: no unit; demands quantity: kW per node per hour
Forecasted energy requirement information of flexible demands, such as EV and HP	Location , quantity and availability	From the prediction of the DSO or a third party service provider	Local or remote	Once a day	Table with integer and floating point numbers	Location: no unit; demands quantity: kWh per EV, temperature setting per HP Availability: no unit
Environment temperature	Predicted temperature	From third party	Remote	Once a day	vector of float numbers	°C

4.1.2.2 Outputs

This is a description of the outputs.

Output	Data exchanged	Destination	Local / Remote	Update schedule	Format	Unit
Algorithm status	Algorithm status: algorithm failed due to missing data; congestion solved; congestion not solved	to DXP	Local	Once a day	Integers	no unit

Grid tariff	Grid tariff	to DXP	Local	Once a day	vector of float numbers	unit: Euro/kWh per hour; in case of LMP: Euro/kWh per node, per hour
Energy plan	The energy plan associated with the determined DADT	to DXP	Local	Once a day	vector of float numbers	kW per node, per hour
Maximum overloading percentage	If the congestion is not solved, the maximum overloading of the energy plan is reported	to DXP	Local	Once a day	vector of float numbers	%

4.1.3 Step-by-step descriptions of the algorithm

1	Connect to the control centre level DXP and read system prices, grid topology, energy requirement of flexible demands, etc. of next day (24 hours). If the data is missing, terminate the algorithm and report a failure due to missing data.
2	Run day-ahead dynamic tariff algorithm: determine the DADT through solving an optimal power flow problem.
2.1	Report the energy plan and determine whether the congestion is solved.
3	Save the grid tariffs and other outputs to the CC level DXP

The flowchart of the algorithm of DADT is shown in Figure 4-1.

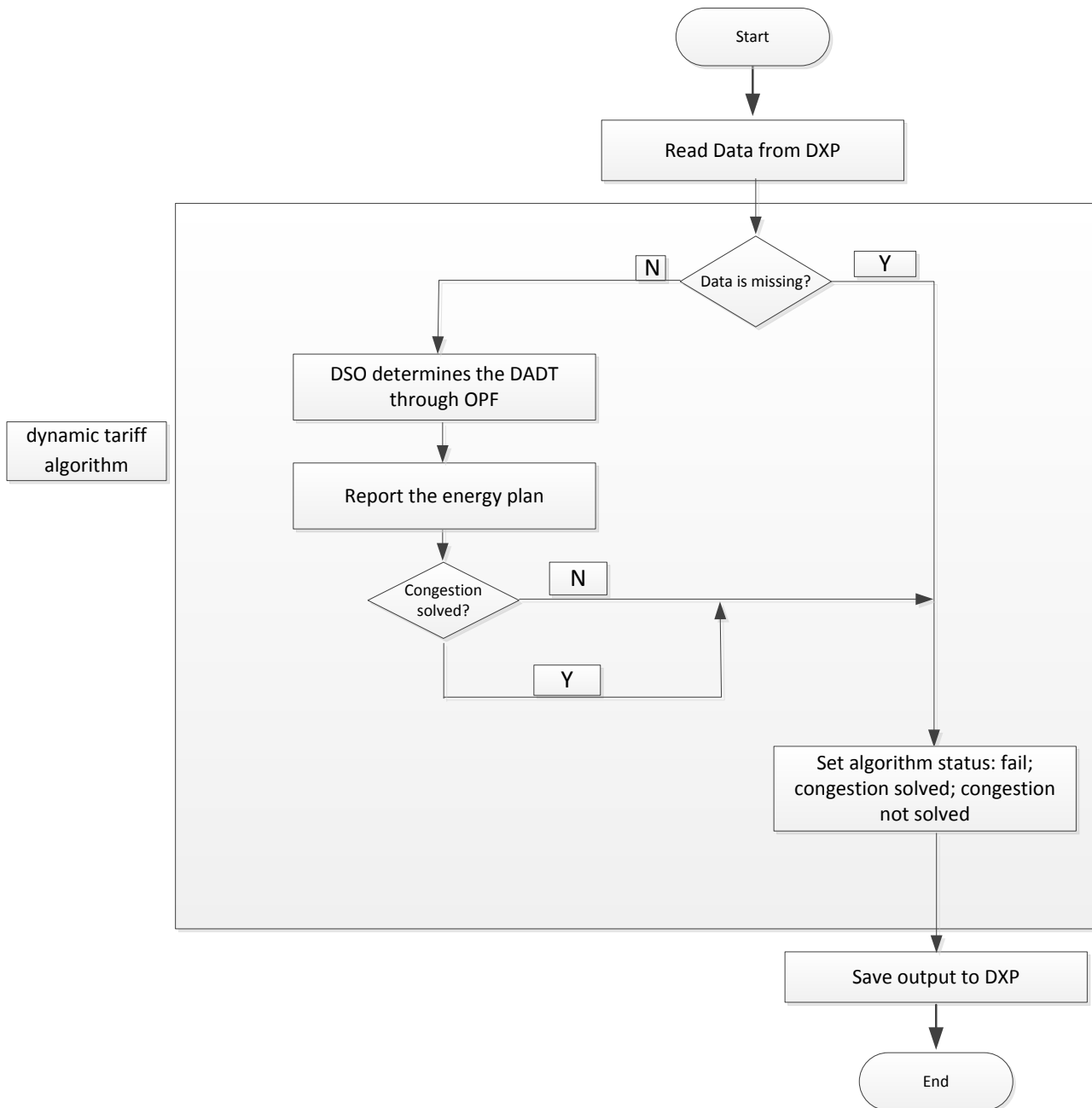

Figure 4-1 Algorithm design of DADT.

4.2 Demand Response Design Specification

4.2.1 Description

The demand response function is performed before the clear of the day-ahead market because after the clear, the demand plan shall be determined and the aggregators or retailers should stick to their plan as much as possible. The demand response function is located at the aggregator side. It is assumed that the aggregators will make an optimal energy plan for their customers based on the predicted energy prices and the DADT received from the DSO.

The steps of the demand response function are as follows:

1. Obtain the input data including system prices, DT, weather forecast, EV driving pattern forecast and customer house temperature requirements for the demand response function, which is provided through the DXP
2. Run the optimization model, where the energy demands, comfort requirements of the customers and the availability of the flexible demands are included as constraints and the cost is the objective function.
3. The optimal demand plan found in step 2 will be sent to the DXP

4.2.2 Interface

This is a description of the interfaces.

4.2.2.1 Inputs

This is a description of the inputs. It should as minimum contain the following:

Input	Data exchanged	Source	Local / Remote	Update schedule	Format	Unit
predicted system price	Predicted day-ahead system prices	From task 5.4 DADT	Local	Once a day	Table of floating point numbers	Euro/kWh per hour
Grid tariff	Grid tariff	From task 5.4 day-ahead grid tariff	Local	Once a day	Table of floating point numbers	Euro/kWh per hour
customer information (customer location, demand type, energy requirement, comfort level, availability)	customer location (node, voltage level), demand type (EV/HP), energy requirement, comfort level (max/min temperature settings), availability	aggregators collect these information from their contracted customers	Remote	Once a day	Table of integers and floating point numbers	Location, demand type, Availability: no unit Energy requirement-electric vehicle: kWh Heat pump temperature settings: °C Household thermal parameters: W/(m ² •K), J/K

4.2.2.2 Outputs

This is a description of the outputs. It should as minimum contain the following:

Output	Data exchanged	Destination	Local / Remote	Update schedule	Format	Unit
Energy plan	Aggregated energy plan of the flexible demands per node/voltage level, per hour	to DXP	Local	Once a day	Table of floating point numbers	kW per node/voltage level, per hour

4.2.3 Step-by-step description of the algorithm

1	Connect to the Control Centre level DXP and Read system prices, grid tariffs and customer data of next day (24 hours).
2	Run optimization algorithm and have an optimized energy plan for all flexible demands. The objective of the optimization is to minimize the energy cost of the flexible demands meanwhile fulfil the energy requirements and the physical constraints of the flexible demands. The optimization algorithm can be simplex algorithm for linear programming and is available in many commercial optimization tools, e.g. MATLAB, GAMS.
3	Save energy plan of the flexible demands at the CC level DXP

The schematic of the algorithm design for demand response is shown in Figure 4-2.

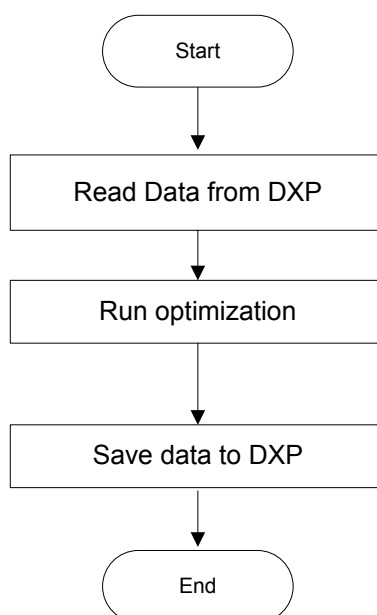

Figure 4-2. Algorithm design of demand response

5 Day Ahead Dynamic Tariff

The concept of the DT method for congestion management has already been proposed in [3], [14] before the start of this project. In this project, the basic theory of this method is further strengthened.

5.1 Background

By extending the locational marginal price (LMP) concept [16] from transmission networks to distribution networks, [17]–[21] have developed the distribution LMP (DLMP) concept and applied it to handle the congestion issues in distribution networks with distributed generators (DGs). Through the DLMP concept, the local DGs will be properly subsidized if they produce more power and reduce the energy requirement of the local bus from remote areas during the congestion hours.

Reference [3] employs the dynamic tariff (DT) concept, which is derived from the DLMP concept, to solve congestion with the flexible demands in distribution networks. The flexible demands may create congestions if the price is not properly set; on the other hand, they can help the congestion management if they are controlled through proper price signals. In [3], the congestion management is conducted in a decentralized manner where the aggregators independently determine the energy plans for the flexible demands without considering the network constraints. The network constraint information is contained in the DT. However, the method proposed in [3] did not consider the inter-temporal characteristics of flexible demands.

In [14], taking into account the inter-temporal characteristics, an integrated DLMP method for determining the DT was proposed. The method proposed in [14] works in most cases. However, the aggregator optimization may have multiple solutions because of the linear programming formulation. The multiple solution issue of the aggregator optimization in the DLMP concept was discussed in [22]. The multiple solutions of the aggregator optimization may cause the centralized DSO optimization and the decentralized aggregator optimization to not converge, and the decentralized congestion management to fail.

Motivated by the multiple solution issue of the decentralized aggregator optimization, this work looks to solve the non-convergence of the centralized DSO optimization and the decentralized aggregator optimization by proposing a new formulation with quadratic programming (QP). The contributions of this work are: (a) Prove the existence of a unique solution of the optimization at both the centralized DSO side and the decentralized aggregator side, and the convergence of these two optimizations through convex QP; (b) Demonstrate that the DLMP concept is valid with the cost function having quadratic terms resulting from the price sensitivity of the DERs; (c) Demonstrate that the DLMP concept can solve congestions caused by mixed flexible demands having different features, i.e. EVs and HPs.

5.2 Optimal Energy Planning for EV and HP

EVs and heat pumps (HPs) meet their energy needs for driving and heating by procuring energy in the day-ahead electricity market. Such purchases can be done through an aggregator representing the EV and HP users by submitting bids on their behalf in the day-ahead electricity market. As such, the individual users shift the burden of market participation to aggregators, and the aggregators get enough capacity to participate in different markets. The day-ahead spot price prediction, and the optimal EV charging and HP planning based on the spot price prediction are explained in this section.

5.2.1 Spot Price Prediction

Before submitting their bids, the aggregators need to determine an optimal energy plan based on the predicted spot prices. The electricity prices are plan-dependent, which poses some difficulty in determining an optimal energy plan because the price is a discontinuous function of the energy plan. A price sensitivity based spot price prediction method was proposed in [13], [23] to deal with such difficulty. Specifically, the predicted price consists of a baseline price plus a linear component proportional to the demand. Therefore, the predicted spot price at time t (hour) is given by,

$$y_t = c_t + \beta_t p_t \tag{5.1}$$

where

y_t is the predicted price,

β_t is the price sensitivity coefficient,

c_t is the baseline price,

p_t is the power consumption of flexible demands.

The price sensitivity coefficient β is determined by evaluating the merit order of the power plants in the electricity market [23]. The production of renewable energy resources, such as wind power (WP) and solar power (SP), is deducted from the conventional demands first. Then the net demands and the flexible demands are met by conventional power plants according to the order of their marginal cost. The function of marginal cost versus demand is fit by an exponential function and β is the first order coefficient of the Taylor expansion of the fit function. The concept of the price sensitivity is illustrated in Figure 5-1. The coefficient β estimated in the above method is scaled up by the total number of available flexible demands (EVs and HPs) in order to be used for individual flexible demand.

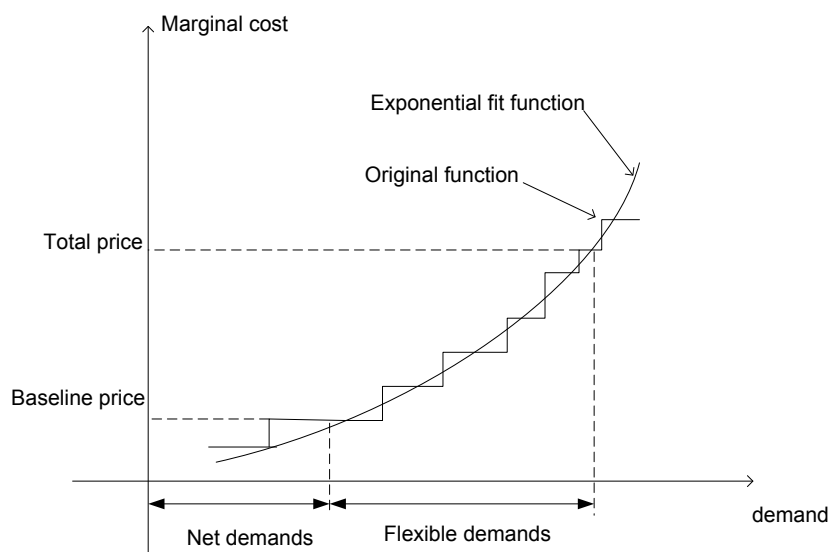

Figure 5-1 Concept of the price sensitivity.

5.2.2 Optimal EV Charging

The optimal EV charging aims to meet the energy needs of EVs with minimum energy cost. Taking into account the price sensitivity, the cost function of the EV charging becomes a quadratic function. The total charging cost of an EV is,

$$\sum_{t \in N_T} y_t p_t = \sum_{t \in N_T} (c_t + \beta_t p_t) p_t = \sum_{t \in N_T} \beta_t p_t^2 + c_t p_t, \quad (5.2)$$

where,

- y_t predicted price ,
- β_t price sensitivity coefficient,
- c_t baseline price,
- p_t charging power of an EV.

With the aggregator concept, the charging plan of the EVs managed by aggregator i at period t can be expressed as $p_{i,t} \in R^{m_i}$.

As such, the optimal EV charging plan can be found by solving the optimization problem below.

$$\min_{p_{i,t}} \sum_{i \in N_B, t \in N_T} \left(\frac{1}{2} p_{i,t}^T B_{i,t} p_{i,t} + (c_t 1)^T p_{i,t} \right) \quad (5.3)$$

subject to,

$$e_i^{\min} \leq \sum_{t_- \leq t} (p_{i,t_-} - d_{i,t_-}) + e_{i,0} \leq e_i^{\max}, \forall t \in N_T, i \in N_B, (\mu_{i,t}^-, \mu_{i,t}^+) \quad (5.4)$$

$$p_{i,t}^{\min} \leq p_{i,t} \leq p_{i,t}^{\max}, \forall i \in N_B, t \in N_T, (\varsigma_{i,t}^-, \varsigma_{i,t}^+) \quad (5.5)$$

where,

- $B_{i,t} \in R^{m_i \times m_i}$ matrix of the price sensitivity coefficient,
- N_B set of aggregators
- N_T set of planning periods
- m_i the number of customers of aggregator i
- n_* cardinality of N_* , i.e. $n_* = |N_*|$

- $d_{i,t} \in R^{m_i}$ discharging power of EVs due to driving,
- $e_i^{\min} \in R^{m_i}$ lower limit of the state of charge (SOC) level,
- $e_i^{\max} \in R^{m_i}$ upper limit of the SOC level,
- $e_{i,0} \in R^{m_i}$ initial SOC level,
- $p_{i,t} \in R^{m_i}$ charging power of EVs of one aggregator,
- $p_{i,t}^{\min} \in R^{m_i}$ lower charging power limit of EVs,
- $p_{i,t}^{\max} \in R^{m_i}$ upper charging power limit of EVs
- $\mu_{i,t}^+ \in R^{m_i}$ Lagrange multiplier (LM) of SOC upper limit constraint
- $\mu_{i,t}^- \in R^{m_i}$ LM of SOC lower limit constraint
- $\zeta_{i,t}^+ \in R^{m_i}$ LM of EV charging power upper limit constraint
- $\zeta_{i,t}^- \in R^{m_i}$ LM of EV charging power lower limit constraint .

Constraint (5.4) ensures that the SOC levels of the batteries are within the specified range. Equations (5.3)-(5.5) form a QP problem.

5.2.3 Optimal HP Planning

The optimal HP planning is to schedule the energy consumption of HPs so as to maintain the house temperature within a specified range at the minimum energy cost. The heat transfer process of the air source HP can be represented by an electric circuit [24] which is illustrated in Figure 5-2. Thus, the following thermal balance equations can be derived [24].

$$Q_t^e + S_t^1 - k_1(K_t^a - K_t) - k_2(K_t^a - K_t^s) = C_a(K_t^a - K_{t-1}^a) \quad \forall t \in N_T \quad (5.6)$$

$$S_t^2 + k_2(K_t^a - K_t^s) - k_3(K_t^s - K_t) = C_s(K_t^s - K_{t-1}^s) \quad \forall t \in N_T \quad (5.7)$$

where,

- C_a heat capacity of the inside air,
- C_s heat capacity of the house structure (walls, etc.),
- K outside temperature,

- K^a house inside temperature,
- K^s structure temperature,
- $K_{i,t}^{a,\min} \in R^{m_i}$ lower temperature limit,
- $K_{i,t}^{a,\max} \in R^{m_i}$ upper temperature limit,
- Q^e thermal energy produced by HP,
- S_t^1 solar irradiation to the inside air,
- S_t^2 solar irradiation to the structure
- k_1 heat transfer coefficient (HTC) between the inside and the outside of the household
- k_2 HTC between the inside and the house structure
- k_3 HTC between the house structure and the outside.

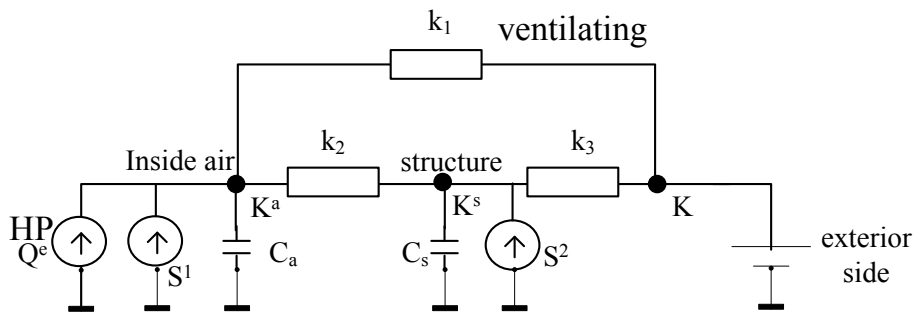

Figure 5-2. Heat transferring process of the house.

Equations (5.6) and (5.7) can be solved iteratively. As a result, the house inside air temperature K_t^a will be a linear combination of all the previous and the current thermal energy (Q_t^e) plus an initial state. Because Q_t^e has a linear relation (by the coefficient of performance (COP)) to the active power \hat{p}_t consumed by the HP, the house inside air temperature can be expressed as,

$$K_t^a = \sum_{t_- \leq t} a_{t,t_-} \hat{p}_{t_-} + u_t \quad \forall t \in N_T \quad (5.8)$$

Finally, the optimization problem of the HP energy plan can be formulated as,

$$\min_{\hat{p}_{i,t}} \sum_{i \in N_B, t \in N_T} \frac{1}{2} \hat{p}_{i,t}^T B_{i,t} \hat{p}_{i,t} + (c_t \mathbf{1})^T \hat{p}_{i,t} \quad (5.9)$$

subject to,

$$K_{i,t}^{a,\min} \leq \sum_{t_- \leq t} A_{i,t,t_-} \hat{p}_{i,t_-} + u_{i,t} \leq K_{i,t}^{a,\max}, \forall i \in N_B, t \in N_T, \quad (5.10)$$

$$(\hat{\mu}_{i,t}^-, \hat{\mu}_{i,t}^+)$$

$$\hat{p}_{i,t}^{\min} \leq \hat{p}_{i,t} \leq \hat{p}_{i,t}^{\max}, \forall i \in N_B, t \in N_T, (\hat{\varsigma}_{i,t}^-, \hat{\varsigma}_{i,t}^+) \quad (5.11)$$

where

N_B set of aggregators

N_T set of planning periods

$A_{i,t,t_-} \in R^{m_i \times m_i}$ is a diagonal matrix,

$u_{i,t} \in R^{m_i}$ represents the initial states,

$\hat{p}_{i,t} \in R^{m_i}$ power consumption of HPs of one aggregator,

$\hat{p}_{i,t}^{\min} \in R^{m_i}$ lower power limit of HPs,

$\hat{p}_{i,t}^{\max} \in R^{m_i}$ upper power limit of HPs

$\hat{\mu}_{i,t}^+ \in R^{m_i}$ LM of upper temperature limit constraint

$\hat{\mu}_{i,t}^- \in R^{m_i}$ LM of lower temperature limit constraint

$\hat{\varsigma}_{i,t}^+ \in R^{m_i}$ LM of HP power upper limit constraint

$\hat{\varsigma}_{i,t}^- \in R^{m_i}$ LM of HP power lower limit constraint.

5.3 DLMP and DT Through QP

5.3.1 Decentralized Congestion Management Through the DLMP and DT Concept

According to [3], [14], the procedure of using the DLMP and DT concept to solve the congestion problem in a decentralized manner can be summarized as follows. Firstly, the DSO obtains the flexible demand data, such as energy requirements and the availability, from the aggregators or by its own prediction. The DSO also needs the network information and the predicted spot price. Secondly, the DLMPs are calculated through the optimal plan respecting the network constraints, and the DTs (DLMPs minus the predicted spot prices) are published to all the aggregators. Thirdly, after receiving the DTs, the aggregators make their own

optimal plans independently with both the predicted spot prices and the DTs. At last, the aggregators submit their energy plan/bids to the spot market.

5.3.2 Multiple Solution Issue of the Aggregator Optimization with Linear Programming Formulation

The multiple solution issue of the aggregator optimization through linear programming was pointed out by the authors of [22] based on the observation of the case study results of [14]. According to the observation, there are an infinite number of optimal solutions of the aggregator optimization due to the equal DLMPs at some load points. The multiple solution issue of the aggregator optimization through linear programming is further discussed in the following analysis.

Assume that there is one EV (or HP) in the distribution network and it is available for energy planning in two periods. It is also assumed that the energy requirement cannot be fulfilled by consuming power in only one period due to the network constraints. For such a case, the DSO optimization is,

$$\min_p c_1 p_1 + c_2 p_2 \quad (5.12)$$

subject to,

$$Dp_1 \leq f_1, (\lambda_1) \quad (5.13)$$

$$Dp_2 \leq f_2, (\lambda_2) \quad (5.14)$$

$$a_1 p_1 + a_2 p_2 \geq b, (\mu) \quad (5.15)$$

$$p_1, p_2 \geq 0, (\varsigma_1, \varsigma_2) \quad (5.16)$$

where,

$D \in R^{n_L \times n_d}$ power transfer distribution factor (PTDF),

$f_t \in R^{n_L}$ is line loading limit available for flexible demands

$\lambda_t \in R^{n_L}$ LM of line loading limit constraint.

Constraints (5.13) and (5.14) are network constraints for the two periods, constraint (5.15) is the energy requirement (derived from (5.4) and (5.10), parameter b is the summation of all constants of (5.4) and (5.10); the upper limit is ignored for simplicity), and constraint (5.16) is to set the lower limit of the consuming power (p_1, p_2) (the upper limit is ignored for simplicity). Coefficients a_1 and a_2 are positive ($a_1 = a_2 = 1$ when it is EV).

According to the KKT conditions, the DLMPs are calculated as (note that $\varsigma_1, \varsigma_2 = 0$ and $p_1, p_2 > 0$, because the energy requirement cannot be fulfilled by any one of them),

$$\begin{aligned} c_1 + D^T \lambda_1 &= \mu a_1 \\ c_2 + D^T \lambda_2 &= \mu a_2 \end{aligned} \quad (5.17)$$

where the terms $D^T\lambda_1$ and $D^T\lambda_2$ are the DTs and should be sent to the aggregator.

The aggregator optimization (no network constraints) is,

$$\min_p (c_1 + \lambda_1^T D)p_1 + (c_2 + \lambda_2^T D)p_2 \quad (5.18)$$

subject to (5.15) and (5.16). It can be seen that such a linear programming has an infinite number of optimal solutions due to the proportional coefficients. The aggregator optimization and the DSO optimization do not converge. For instance, the optimal energy plan of the aggregator optimization, where $p_1 = 0$, is infeasible for the DSO optimization because the energy requirement cannot be fulfilled by any one of p_1, p_2 , as stated in the assumption.

When there are many flexible demands in the distribution network, the above analysis is still valid, as there is at least one flexible demand behaving like the one in the above example. As such, the decentralized congestion management formulated through linear programming fails.

5.3.3 QP Formulation and the Proof of Convergence

5.3.3.1 DSO Optimization Through QP:

The DSO optimization in the second step of the procedures in Section 4.3.1 is,

$$\min_{p_{i,t}, \hat{p}_{i,t}} \sum_{i \in N_B, t \in N_T} \frac{1}{2} p_{i,t}^T B_{i,t} p_{i,t} + (c_t 1)^T p_{i,t} + \frac{1}{2} \hat{p}_{i,t}^T B_{i,t} \hat{p}_{i,t} + (c_t 1)^T \hat{p}_{i,t} \quad (5.19)$$

subject to,

$$\sum_{i \in N_B} DE_i(p_{i,t} + \hat{p}_{i,t}) \leq f_t, \forall t \in N_T, (\lambda_t) \quad (5.20)$$

together with (5.4), (5.5), (5.10) and (5.11), where, $E_i \in R^{n_d \times m_i}$ is customer to load bus mapping matrix.

The conventional household demands are assumed to be inflexible. Therefore, they are not included in the objective function (5.19), but reflected in the line loading limits f_t , which are the total line capacities excluding the loadings induced by the conventional demands.

The DTs, defined as $D^T\lambda_t$, will be published by the DSO before the day-ahead market clears. Parameters c_t and β_t used by the DSO are shared with the aggregators since the aggregators need them in their optimization problems.

5.3.3.2 Aggregator Optimization Through QP:

Aggregator i first forms the DLMP for each of his customers, i.e. $c_t 1 + E_i^T D^T \lambda$. Then, the optimal energy plan of aggregator i can be formulated as,

$$\min_{p_{i,t}, \hat{p}_{i,t}} \sum_{t \in N_T} \frac{1}{2} p_{i,t}^T B_{i,t} p_{i,t} + (c_i 1 + E_i^T D^T \lambda_t)^T p_{i,t} + \frac{1}{2} \hat{p}_{i,t}^T B_{i,t} \hat{p}_{i,t} + (c_i 1 + E_i^T D^T \lambda_t)^T \hat{p}_{i,t} \quad (5.21)$$

subject to,

$$e_i^{\min} \leq \sum_{t \leq t} (p_{i,t} - d_{i,t}) + e_{i,0} \leq e_i^{\max}, \forall t \in N_T, (\mu_{i,t}^-, \mu_{i,t}^+) \quad (5.22)$$

$$p_{i,t}^{\min} \leq p_{i,t} \leq p_{i,t}^{\max} \quad \forall t \in N_T, (\zeta_{i,t}^-, \zeta_{i,t}^+) \quad (5.23)$$

$$K_{i,t}^{a,\min} \leq \sum_{t \leq t} A_{i,t} \hat{p}_{i,t} + u_{i,t} \leq K_{i,t}^{a,\max}, \forall t \in N_T, (\hat{\mu}_{i,t}^-, \hat{\mu}_{i,t}^+) \quad (5.24)$$

$$\hat{p}_{i,t}^{\min} \leq \hat{p}_{i,t} \leq \hat{p}_{i,t}^{\max} \quad t \in N_T, (\hat{\zeta}_{i,t}^-, \hat{\zeta}_{i,t}^+) \quad (5.25)$$

5.3.3.3 Proof of the Convergence of the DSO Optimization and the Aggregator Optimization Through QP:

The KKT conditions of the DSO optimization are,

$$B_{i,t} p_{i,t} + c_i 1 + E_i^T D^T \lambda_t + \sum_{t \leq t} (\mu_{i,t}^+ - \mu_{i,t}^-) + (\zeta_{i,t}^+ - \zeta_{i,t}^-) = 0, \forall i \in N_B, t \in N_T \quad (5.26)$$

$$B_{i,t} \hat{p}_{i,t} + c_i 1 + E_i^T D^T \lambda_t + \sum_{t \leq t} (\hat{\mu}_{i,t}^+ - \hat{\mu}_{i,t}^-) + (\hat{\zeta}_{i,t}^+ - \hat{\zeta}_{i,t}^-) = 0, \forall i \in N_B, t \in N_T \quad (5.27)$$

$$\left(\sum_i D E_i p_{i,t} - f_t \right) \cdot \lambda_t = 0, \quad \forall t \in N_T \quad (5.28)$$

$$\left(\sum_{t \leq t} (p_{i,t} - d_{i,t}) + e_{i,0} - e_i^{\max} \right) \cdot \mu_{i,t}^+ = 0, \forall t \in N_T, i \in N_B \quad (5.29)$$

$$\left(\sum_{t \leq t} (p_{i,t} - d_{i,t}) + e_{i,0} - e_i^{\min} \right) \cdot \mu_{i,t}^- = 0, \forall t \in N_T, i \in N_B \quad (5.30)$$

$$(p_{i,t} - p_{i,t}^{\max}) \cdot \zeta_{i,t}^+ = 0, \forall i \in N_B, t \in N_T \quad (5.31)$$

$$(p_{i,t} - p_{i,t}^{\min}) \cdot \zeta_{i,t}^- = 0, \forall i \in N_B, t \in N_T \quad (5.32)$$

$$\left(\sum_{t \leq t} A_{i,t} \hat{p}_{i,t} + u_{i,t} - K_{i,t}^{a,\max} \right) \cdot \hat{\mu}_{i,t}^+ = 0, \forall i \in N_B, t \in N_T \quad (5.33)$$

$$\left(\sum_{t \leq t} A_{i,t} \hat{p}_{i,t} + u_{i,t} - K_{i,t}^{a,\min} \right) \cdot \hat{\mu}_{i,t}^- = 0, \forall i \in N_B, t \in N_T \quad (5.34)$$

$$(\hat{p}_{i,t} - \hat{p}_{i,t}^{\max}) \cdot \hat{\zeta}_{i,t}^+ = 0, \forall i \in N_B, t \in N_T \quad (5.35)$$

$$(\hat{p}_{i,t} - \hat{p}_{i,t}^{\min}) \cdot \hat{\zeta}_{i,t}^- = 0, \forall i \in N_B, t \in N_T \quad (5.36)$$

$$\lambda_t \geq 0, \forall t \in N_T \quad (5.37)$$

$$\mu_{i,t}^+, \mu_{i,t}^-, \zeta_{i,t}^+, \zeta_{i,t}^-, \hat{\mu}_{i,t}^+, \hat{\mu}_{i,t}^-, \hat{\zeta}_{i,t}^+, \hat{\zeta}_{i,t}^- \geq 0, \forall i \in N_B, t \in N_T \quad (5.38)$$

together with the constraints (5.4), (5.5), (5.10), (5.11) and (5.20).

Similarly, the KKT conditions of the aggregator i optimization are,

$$B_i p_{i,t} + c_t 1 + E_i^T D^T \lambda_t + \sum_{t_- \leq t} (\mu_{i,t_-}^+ - \mu_{i,t_-}^-) + (\zeta_{i,t}^+ - \zeta_{i,t}^-) = 0, \forall t \in N_T \quad (5.39)$$

$$B_i \hat{p}_{i,t} + c_t 1 + E_i^T D^T \lambda_t + \sum_{t_- \leq t} (\hat{\mu}_{i,t_-}^+ - \hat{\mu}_{i,t_-}^-) + (\hat{\zeta}_{i,t}^+ - \hat{\zeta}_{i,t}^-) = 0, \forall t \in N_T \quad (5.40)$$

$$\left(\sum_{t_- \leq t} (p_{i,t_-} - d_{i,t_-}) + e_{i,0} - e_i^{\max} \right) \cdot \mu_{i,t}^+ = 0, \forall t \in N_T \quad (5.41)$$

$$\left(\sum_{t_- \leq t} (p_{i,t_-} - d_{i,t_-}) + e_{i,0} - e_i^{\min} \right) \cdot \mu_{i,t}^- = 0, \forall t \in N_T \quad (5.42)$$

$$(p_{i,t} - p_{i,t}^{\max}) \cdot \zeta_{i,t}^+ = 0, \forall t \in N_T \quad (5.43)$$

$$(p_{i,t} - p_{i,t}^{\min}) \cdot \zeta_{i,t}^- = 0, \forall t \in N_T \quad (5.44)$$

$$\left(\sum_{t_- \leq t} A_{i,t,t_-} \hat{p}_{i,t_-} + u_{i,t} - K_{i,t}^{a,\max} \right) \cdot \hat{\mu}_{i,t}^+ = 0, \forall t \in N_T \quad (5.45)$$

$$\left(\sum_{t_- \leq t} A_{i,t,t_-} \hat{p}_{i,t_-} + u_{i,t} - K_{i,t}^{a,\min} \right) \cdot \hat{\mu}_{i,t}^- = 0, \forall t \in N_T \quad (5.46)$$

$$(\hat{p}_{i,t} - \hat{p}_{i,t}^{\max}) \cdot \hat{\zeta}_{i,t}^+ = 0, \forall t \in N_T \quad (5.47)$$

$$(\hat{p}_{i,t} - \hat{p}_{i,t}^{\min}) \cdot \hat{\zeta}_{i,t}^- = 0, \forall t \in N_T \quad (5.48)$$

together with (5.22)-(5.25) and (5.38).

It can be seen that the objective function (5.19) of the DSO problem is a quadratic function with all quadratic terms being positive and no cross terms. Therefore, the Hessian matrix can be found by observation. Particularly, it is a diagonal matrix with the elements being the coefficients of the quadratic terms in (5.19), which are all positive. A diagonal matrix with all elements being positive is a positive definite matrix; therefore, the Hessian matrix of (5.19) is positive definite.

Since the objective function (5.19) is a quadratic function with positive definite Hessian matrix and all the constraints, i.e. (5.4), (5.5), (5.10), (5.11) and (5.20) are affine functions, the DSO optimization problem is a strictly convex QP problem, which has a unique minimizer [25] assuming the problem is feasible. Moreover, the KKT conditions of the DSO optimization problem are necessary and sufficient [25].

Similarly, it can be inferred from (5.21)-(5.25) that each aggregator optimization problem is also a strictly convex QP problem. Therefore, each of them has a unique minimizer and the KKT conditions are necessary and sufficient.

Now, suppose

$$(p_{i,t}^*, \hat{p}_{i,t}^*, \lambda_t^*, \mu_{i,t}^{+*}, \mu_{i,t}^{-*}, \varsigma_{i,t}^{+*}, \varsigma_{i,t}^{-*}, \hat{\mu}_{i,t}^{+*}, \hat{\mu}_{i,t}^{-*}, \hat{\varsigma}_{i,t}^{+*}, \hat{\varsigma}_{i,t}^{-*})$$

is a solution of the KKT conditions of the DSO problem ((5.4), (5.5), (5.10), (5.11), (5.20) and (5.26)-(5.38)), implying that $(p_{i,t}^*, \hat{p}_{i,t}^*)$ is a solution of the problem. By comparing the KKT conditions, it can be seen that, with respect to aggregator i ,

$$(p_{i,t}^*, \hat{p}_{i,t}^*, \mu_{i,t}^{+*}, \mu_{i,t}^{-*}, \varsigma_{i,t}^{+*}, \varsigma_{i,t}^{-*}, \hat{\mu}_{i,t}^{+*}, \hat{\mu}_{i,t}^{-*}, \hat{\varsigma}_{i,t}^{+*}, \hat{\varsigma}_{i,t}^{-*})$$

is also satisfying (5.22)-(5.25) and (5.38)-(5.48), i.e. the KKT conditions of the aggregator problem. This means $(p_{i,t}^*, \hat{p}_{i,t}^*)$ is also a solution of the aggregator problem. Because any solution of the DSO problem must satisfy the KKT conditions of it, it can be concluded that any solution of the DSO problem is also a solution to the aggregator problem.

On the other hand, a solution that satisfies the KKT conditions of the aggregator problems does not necessarily satisfy the KKT conditions of the DSO problem, because the switching condition (5.28) of the DSO problem is not respected by the aggregator problems. However, due to the uniqueness of the solution to the DSO problem and the aggregator problems, any solution of the aggregator problems must also be a solution of the DSO problem. This can be proven by contradiction.

Suppose $(p_{i,t}^{**}, \hat{p}_{i,t}^{**})$ is a solution of the aggregator problems but not to the DSO problem. Suppose $(p_{i,t}^*, \hat{p}_{i,t}^*)$ is a solution to the DSO problem. Then, according to the previous conclusion, $(p_{i,t}^*, \hat{p}_{i,t}^*)$ is also a solution to the aggregator problems. Due to the uniqueness of the aggregator problems, there is $(p_{i,t}^*, \hat{p}_{i,t}^*) = (p_{i,t}^{**}, \hat{p}_{i,t}^{**})$ and it contradicts to the assumption that $(p_{i,t}^{**}, \hat{p}_{i,t}^{**})$ is not a solution to the DSO problem. Therefore, it can be concluded that any solution to the aggregator problems is also a solution to the DSO problem. Based on the above conclusions, the DSO problem and the aggregator problems do converge.

5.4 Case Studies

Case studies were conducted using the Danish driving pattern and the Bus 4 distribution system of the Roy Billinton Test System (RBTS) [26]. The details of the case studies are presented in this section.

5.4.1 Grid Data

The single line diagram of the Bus 4 distribution network is shown in Figure 5-3. Line segments of the feeder one are labelled in Figure 5-3, among which L2, L4, L6, L8, L9, L11, and L12 refer to the transformers

connecting the corresponding load points (LP1 to LP7). The study is focused on this feeder because it has the most diversity among all the feeders: 5 residential load points with different peak conventional demands and two commercial load points. The detailed data of these load points are listed in Table 5-1. The peak conventional demands of residential customers are assumed to occur at 18:00 when people come home and start cooking (shown in Figure 5-5).

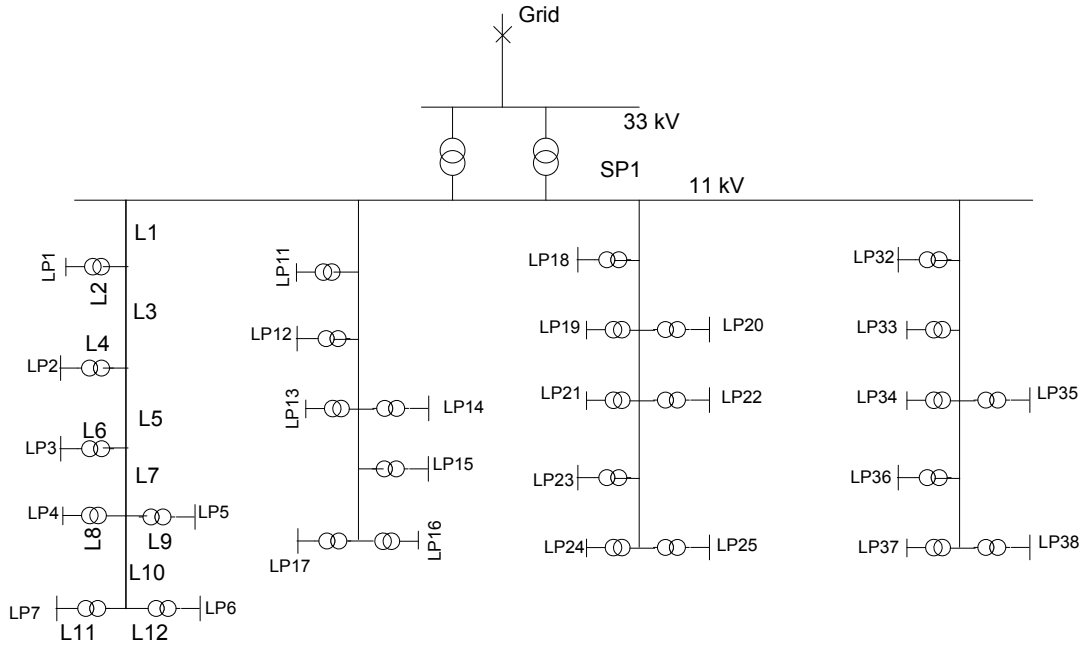

Figure 5-3. Single line diagram of the distribution network.

Table 5-1

Load Point Data

load points	customer type	peak conv. load point (kW)	number of customers per point
LP1-LP4	residential	886.9	200
LP5	residential	813.7	200
LP6,LP7	commercial	671.4	10

5.4.2 EV and HP Data

The key parameters of EVs and HPs are listed in Table 5-2. The EV availability shown in Figure 5-4 is from the driving pattern study in [27]. The household area is a random number between 100 and 200 (m²).

Table 5-2
Key Parameters of EVs and HPs ([27], [28])

parameter	value
EV battery size	25 kWh
Peak charging power	11 kW (3 phase)
Energy consumption per km	150 Wh/km
Minimum SOC	20%
Maximum SOC	85%
Average driving distance	40 km
COP of HP	2.3
Min Temp. of the House	20 °C
Max Temp. of the House	24 °C

5.4.3 Case Study Results

In the case study, it is assumed that there are two aggregators. The aggregator 'aag1' has contracts with 40 customers per load point while the other has contracts with the other 160 customers per load point. The line loading limits of all line segments are listed in Table 5-3, which are higher than the peak conventional demands but lower than the peak demands including EVs and HPs.

The simulation was carried out using the General Algebraic Modeling System (GAMS) optimization software [29] although many other tools can be used such as QUADPROG in MATLAB, Gurobi and AMPL. Firstly, the DSO optimization problem was carried out and the results are shown in Figure 5-5 (due to the space limitation, only the results of line L2-L4 were plotted). Because the line loading limits are respected in the optimization, the line loadings of all line segments are lower than the limits.

It can be seen from Figure 5-5 that the line loadings reach (but do not exceed) the limits at hour 16-18 (only line L2) and hour 23-24. This means that the corresponding inequality constraints of the optimization problem are 'active' and the Lagrange multipliers of these constraints are positive. Therefore, according to the DLMP calculation method described in Section 4.3.3, the DLMPs are higher than the base price (shown

in Figure 5-6 and Table 5-4). The prices of LP1 at hour 17-18 are very high and are cropped in Figure 5-6 (they can be found in Table 5-4) in order to have a better illustration of DLMPs of other hours. The high prices of LP1 at hour 17-18 can be explained by analyzing the nature of the congestion caused by HPs. HPs are less sensitive to the prices compared to EVs because of the significant thermal leakages of the households; therefore, higher DLMPs are required to solve the congestion caused by them.

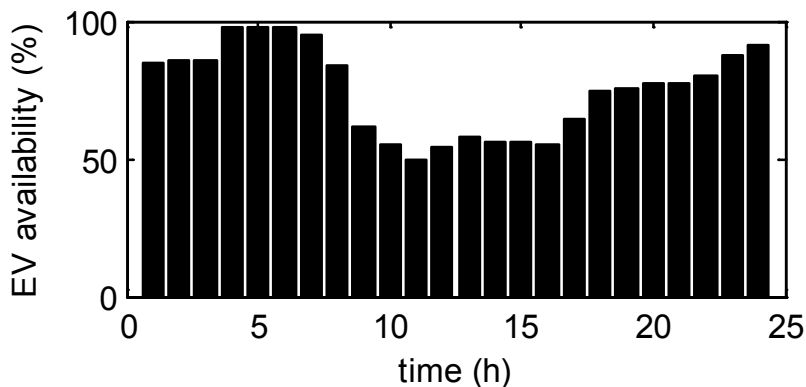

Figure 5-4. EV availability

Table 5-3

Line Loading Limit

line	L2	L3	L4	L8	L9
limit (kW)	1400	7000	1700	1600	1500

Table 5-4

DLMPs (DKK/kWh) Due to Multiple Congestions on L2, L3, L4, L8 and L9 ('-' Means Equal to Base Price)

time	5	16	17	18	23	24
base price	0.3012	0.3884	0.3513	0.3313	0.2941	0.2241
LP1	-	0.5611	1.1006	2.4335	0.3012	0.3012
LP2	-	-	-	-	-	0.2940
LP3	-	-	-	-	-	0.2937

LP4	-	-	-	-	0.3006	0.3006
LP5	-	-	-	-	0.3008	0.3008

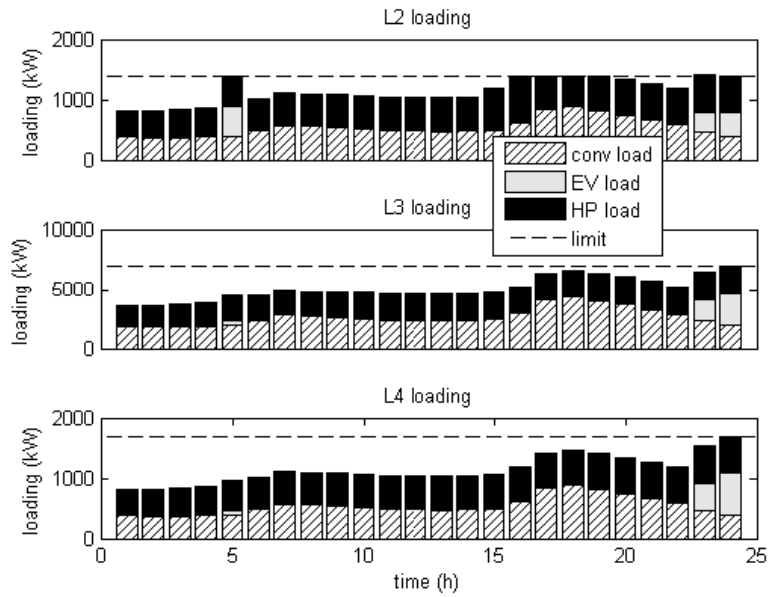

Figure 5-5. Line loading of the DSO problem

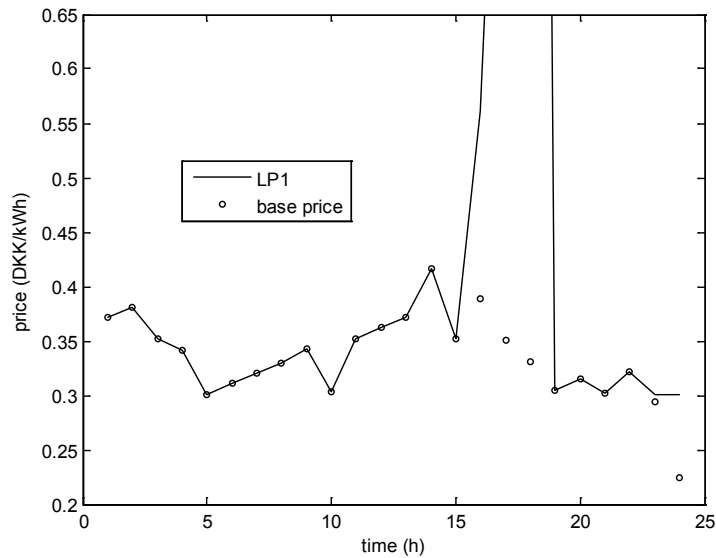

Figure 5-6. System prices and DLMPs at LP1

Secondly, the aggregator optimization was performed. Two aggregators carried out their own optimization problem independently.

In order to clearly show the effect of the DLMP, two case studies were conducted. In Case One, the DLMP was not applied; in Case Two, the DLMP was applied.

As expected, when the DLMP is not applied, congestions occur at 24:00 and 18:00 (shown in Figure 5-7). At 24:00, because the system price is the lowest, every EV wants to charge its battery as long as it is available for charging. The simultaneous charging leads to the very high peak. Overloading of line L2 at 18:00, however, is not due to the low price. In fact, it is the peak conventional demand that has consumed most of the capacity of the line and the available capacity is not enough for the HP demands.

When the DLMP is applied, the congestions are alleviated (shown in Figure 5-8). Due to the posed DTs, the DLMP at load points LP1 at 24:00 is as attractive as the ones at 23:00 and 5:00. Therefore, the EV charging demands are spread at those hours and the resulted peak is not higher than the limits. The previous congestion of line L2 at 18:00 also disappears due to the DLMP. The DLMP at LP1 at 18:00 is so high that the HPs choose to produce more heat before 18:00 and due to the dynamics of the thermal objects (house inside air, house structure), the temperature at 18:00 is maintained between the lower and upper limits. Hence, the HP demands are shifted to the previous hours when the conventional demands are low enough to accommodate them.

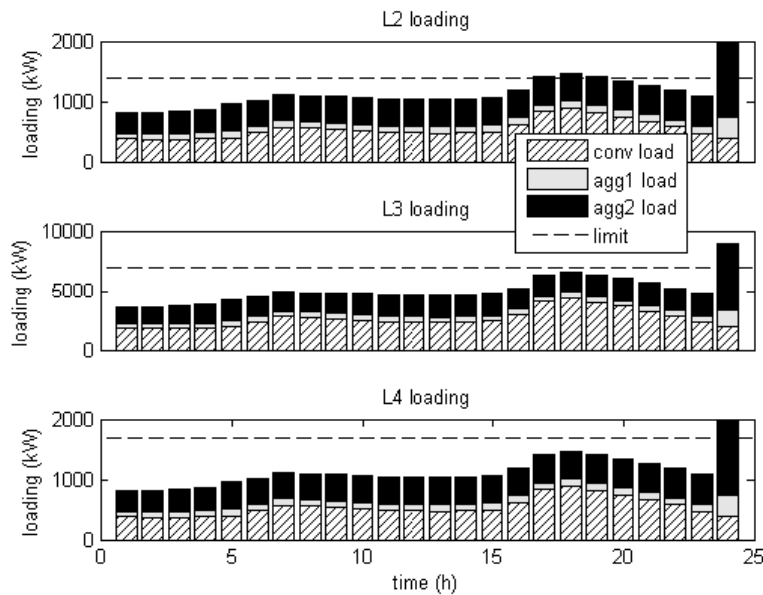

Figure 5-7. Line loading without DLMP

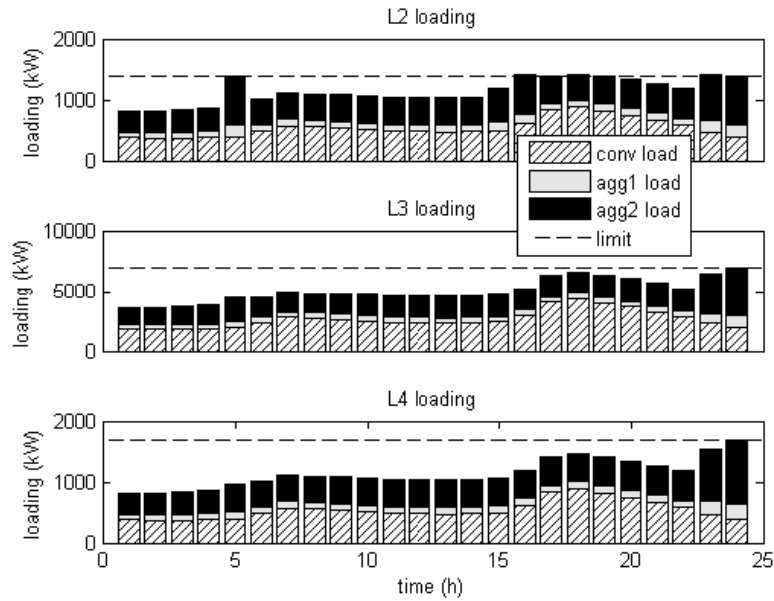

Figure 5-8. Line loading with DLMP

In order to illustrate the non-convergence issue that might occur with the linear programming formulation, a simulation was conducted where the price sensitive part was excluded. Without the price sensitive part, the DSO optimization problem and the aggregator optimization problems are linear programming problems. The DLMPs were calculated and shown in Table 5-5. It can be seen that the DLMPs of LP1 are the same at time 5, 23 and 24 hour. This will lead to infinite solutions of the aggregator problems. As a result, the aggregator may not act as the DSO expects. This is confirmed by the simulation results in Figure 5-9 and Figure 5-10. In Figure 5-9, for the DSO optimization, there is no congestion, however, in Figure 5-10, for the aggregator optimization, congestions occur at line L2; loading of line L3 at 5 hour is different.

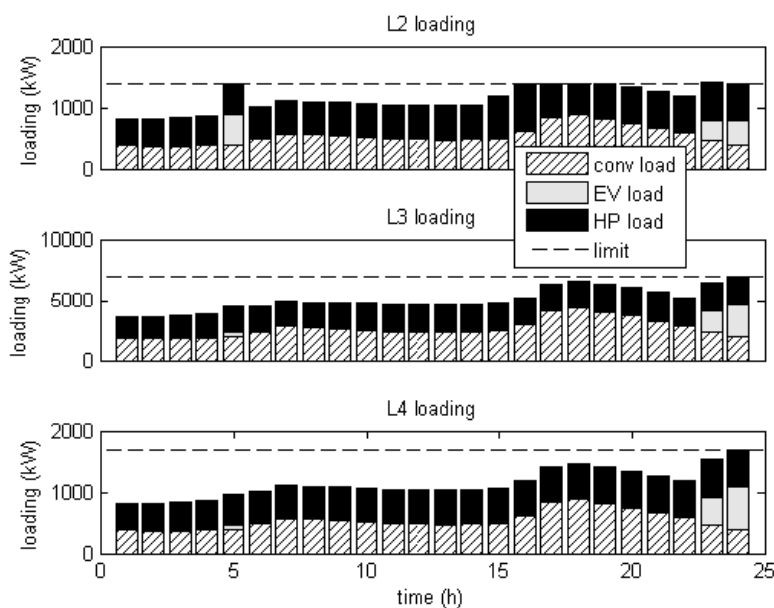

Figure 5-9. Line loading of the DSO problem excluding quadratic terms

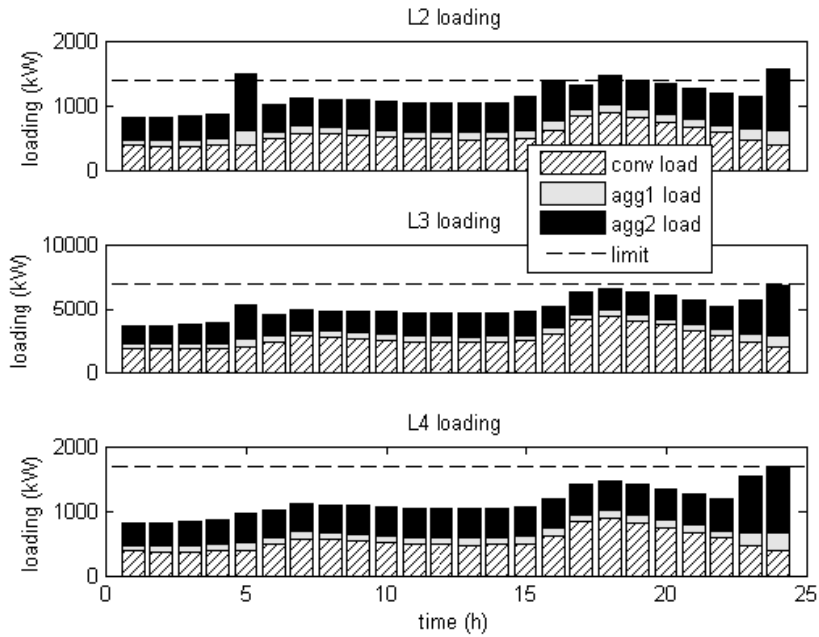

Figure 5-10. Line loading of the aggregator problems excluding quadratic terms

Table 5-5

DLMPs (DKK/kWh) with Multiple Congestions at L2, L3, L4, L8 and L9 ('-' : Eq. to Base Price), Calc. without Quadratic Terms

time	5	16	17	18	23	24
base price	0.3012	0.3884	0.3513	0.3313	0.2941	0.2241
LP1	-	0.5605	1.0984	2.4267	0.3012	0.3012
LP2	-	-	-	-	-	0.2941
LP3	-	-	-	-	-	0.2941
LP4	-	-	-	-	0.3012	0.3012
LP5	-	-	-	-	0.3012	0.3012

5.5 Conclusion

Though the DLMP and DT concept is efficient in alleviating congestions in distribution networks with high penetration of flexible demands, the formulation of the decentralized aggregator optimization must be carefully handled. With the linear programming formulation of the aggregator optimization, there might be multiple solutions of the decentralized aggregator optimization. The multiple solutions of the aggregator

optimization may cause the centralized DSO optimization and the decentralized aggregator optimization to not converge, and the decentralized congestion management to fail.

The multiple solution issue of the aggregator optimization is addressed in this work by introducing price sensitivity which leads to strictly convex QP formulations for both the DSO optimization and the aggregator optimization. The convergence of the centralized DSO optimization and the decentralized aggregator optimization with the QP formulation is proven, which ensures that the aggregators act as the DSO expects. The case study results have demonstrated the convergence of the DSO optimization and the aggregator optimization with the strictly convex QP formulation, and the efficacy of the DLMP through QP for congestion management.

For the future work, more practical features of the distribution network can be considered, such as high R/X ratio, losses, single phase loads and unbalance. It is interesting to study how these factors will affect the DLMP concept for congestion management. In addition to the line loading constraints, the voltage constraints shall also be studied in the future work.

6 CONCLUSIONS

In this report, two categories of the DR programs, namely incentive-based programs and price-based programs, are reviewed. With the incentive-based programs, the customers can get a reward if they change their consumption behaviour so that it favours the operation of the power system. With the price-based programs, the customers will change their consumption behaviour so that it benefits the power system if they want to optimize their energy planning according to the prices, which reflect the energy costs and the congestion costs. Therefore, both incentives and prices can influence the behaviour of the customers. The DSO can choose DR programs according to their own situation and the regulatory rules.

Among all these DR programs, the DADT is a very efficient one, which belongs to the price-based programs. In this report, the DADT is further developed. The QP based DADT is proposed to solve the multiple-solution issue and make the DADT more efficient and robust in terms of control structure and sensitivity of parameter disturbance. Offline simulations have demonstrated that the DADT is efficient in solving congestions in a distribution network with high penetration of EVs and HPs.

In order to implement the DADT method for congestion management in distribution networks, the design specifications and algorithms for calculating the DADT rates at the DSO side and the DR at the customer side have been presented, respectively. The interfaces with other tasks in work package 5 of IDE4L were also presented. The step-by-step procedures of the algorithm are described.

In the future, the DADT can be further studied with respect to, for instance, forecast of the flexible demands, forecast of the energy price, estimation of the price sensitivity and the situation where DADT is not able to fully solve congestions. In reality, the relation between the traditional network tariff and DADT should also be studied.

Reference

- [1] B. Biegel, P. Andersen, J. Stoustrup, and J. Bendtsen, "Congestion management in a smart grid via shadow prices," in *Proc. 8th IFAC Symposium on Power Plant and Power System Control*, pp. 518–523.
- [2] J. Hu, S. You, M. Lind, and J. Ostergaard, "Coordinated charging of electric vehicles for congestion prevention in the distribution grid," *IEEE Trans. Smart Grid*, vol.5, no.2, pp. 703–711, Mar. 2014.
- [3] N. O'Connell, Q. Wu, J. Østergaard, A. H. Nielsen, S. T. Cha, and Y. Ding, "Day-ahead tariffs for the alleviation of distribution grid congestion from electric vehicles," *Electr. Power Syst. Res.*, vol.92, pp. 106–114, 2012.
- [4] A. R. Malekpour, A. R. Seifi, M. R. Hesamzadeh, and N. Hosseinzadeh, "An optimal load shedding approach for distribution networks with DGs considering capacity deficiency modelling of bulked power supply," in *Proc. Power Engineering Conference*, pp. 1–7.
- [5] M. Alonso, H. Amarís, C. Álvarez, and R. Albarracín, "Reactive power planning in distribution networks with distributed generation," in *Proc. 7th Mediterranean Conference and Exhibition on Power Generation, Transmission, Distribution and Energy Conversion (MedPower 2010)*, pp. 1–7.
- [6] Federal Energy Regulatory Commission, "Assessment of demand response and advanced metering," 2012.
- [7] S. Mohajeryami, P. Schwarz, and P. T. Baboli, "Including the behavioral aspects of customers in demand response model: Real time pricing versus peak time rebate," in *Proc. 2015 North American Power Symposium (NAPS)*, pp. 1–6.
- [8] H. Zhong, L. Xie, and Q. Xia, "Coupon Incentive-Based Demand Response: Theory and Case Study," *IEEE Trans. Power Syst.*, vol.28, no.2, pp. 1266–1276, May 2013.
- [9] M. R. Sarker, M. A. Ortega-Vazquez, and D. S. Kirschen, "Optimal Coordination and Scheduling of Demand Response via Monetary Incentives," *IEEE Trans. Smart Grid*, vol.6, no.3, pp. 1341–1352, May 2015.
- [10] C. Zhang, Y. Ding, N. Nordentoft, P. Pinson, and J. Østergaard, "FLECH-A danish market solution for DSO congestion management through DER flexibility services," *J. Mod. Power Syst. Clean Energy*, vol.2, no.2, pp. 126–133, 2014.
- [11] S. Perälä, "New network tariffs: Economical effects and possibilities for demand response," Tampere University of Technology, 2011.
- [12] H. Partanen, J., Honkapuro, S., Tuunanen, J and Niemelä. (2012). Tariff scheme options for distribution system operators. LUT. [online]. Available: <http://www.lut.fi/documents/10633/138922/Tariff+scheme+options+for+distribution+system+operators/d2c7a66f-4033-42ff-a581-dc4ef8586592>.
- [13] R. A. Verzijlbergh, L. J. De Vries, and Z. Lukszo, "Renewable energy sources and responsive demand. Do we need congestion management in the distribution grid?," *IEEE Trans. Power Syst.*, pp. 1–10, 2014.

- [14] R. Li, Q. Wu, and S. S. Oren, "Distribution locational marginal pricing for optimal electric vehicle charging management," *IEEE Trans. Power Syst.*, vol.29, no.1, pp. 203–211, Jan. 2014.
- [15] P. Bach Andersen, J. Hu, and K. Heussen, "Coordination strategies for distribution grid congestion management in a multi-actor, multi-objective setting," in *Proc. 3rd IEEE PES Innovative Smart Grid Technologies Europe (ISGT Europe)*, pp. 1–8.
- [16] R. Bohn, M. Caramanis, and F. Schweppe, "Optimal pricing in electrical networks over space and time," *RAND J. Econ.*, vol.15, no.3, pp. 360–376, 1984.
- [17] P. M. Sotkiewicz and J. M. Vignolo, "Nodal Pricing for Distribution Networks: Efficient Pricing for Efficiency Enhancing DG," *IEEE Trans. Power Syst.*, vol.21, no.2, pp. 1013–1014, May 2006.
- [18] R. K. Singh and S. K. Goswami, "Optimum allocation of distributed generations based on nodal pricing for profit, loss reduction, and voltage improvement including voltage rise issue," *Int. J. Electr. Power Energy Syst.*, vol.32, no.6, pp. 637–644, Jul. 2010.
- [19] F. Meng and B. H. Chowdhury, "Distribution LMP-based economic operation for future smart grid," in *Proc. 2011 IEEE Power and Energy Conference at Illinois*, pp. 1–5.
- [20] G. T. Heydt, B. H. Chowdhury, M. L. Crow, D. Haughton, B. D. Kiefer, F. Meng, and B. R. Sathyanarayana, "Pricing and control in the next generation power distribution system," *IEEE Trans. Smart Grid*, vol.3, no.2, pp. 907–914, Jun. 2012.
- [21] K. Shaloudegi, N. Madinehi, S. H. Hosseinian, and H. A. Abyaneh, "A novel policy for locational marginal price calculation in distribution systems based on loss reduction allocation using game theory," *IEEE Trans. Power Syst.*, vol.27, no.2, pp. 811–820, May 2012.
- [22] W. Liu and F. Wen, "Discussion on 'Distribution Locational Marginal Pricing for Optimal Electric Vehicle Charging Management,'" *IEEE Trans. Power Syst.*, vol.29, no.4, pp. 1866–1866, Jul. 2014.
- [23] R. A. Verzijlbergh, Z. Lukszo, and M. D. Ilic, "Comparing different EV charging strategies in liberalized power systems," in *Proc. 9th International Conference on the European Energy Market*, pp. 1–8.
- [24] P. Bacher and H. Madsen, "Identifying suitable models for the heat dynamics of buildings," *Energy Build.*, vol.43, no.7, pp. 1511–1522, Jul. 2011.
- [25] S. Boyd and L. Vandenberghe, *Convex Optimization*. Cambridge University Press, 2004.
- [26] R. N. Allan, R. Billinton, I. Sjarief, L. Goel, and K. S. So, "A reliability test system for educational purposes-basic distribution system data and results," *IEEE Trans. Power Syst.*, vol.6, no.2, pp. 813–820, May 1991.
- [27] Q. Wu, A. H. Nielsen, J. Østergaard, F. Marra, and C. Træholt, "Driving pattern analysis for electric vehicle (EV) grid integration study," in *Proc. 2010 IEEE PES Innovative Smart Grid Technologies Conference Europe (ISGT Europe)*, pp. 1–6.
- [28] J. M. Nyers and A. J. Nyers, "COP of heating-cooling system with heat pump," in *Proc. IEEE 3rd International Symposium on Exploitation of Renewable Energy Sources (EXPRES)*, pp. 17–21.

- [29] R. E. Rosenthal. (2014, Aug.). GAMS — A user’s guide. GAMS Development Corporation, Washington, DC, USA. [online]. Available:
<http://www.gams.com/dd/docs/bigdocs/GAMSUsersGuide.pdf>.